

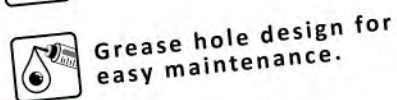

2016

Content

INTRO



Replaceable Pin



USED TO

THIN & LIGHT



CITY

LU-884

33mm



C098

23.7mm



MTB

LU-954

30.3mm



M-21

24mm



BMX

LU-A8

34.4mm



B252

17.5mm



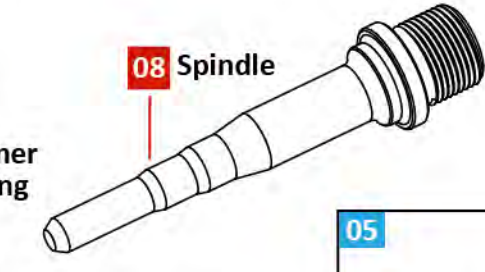
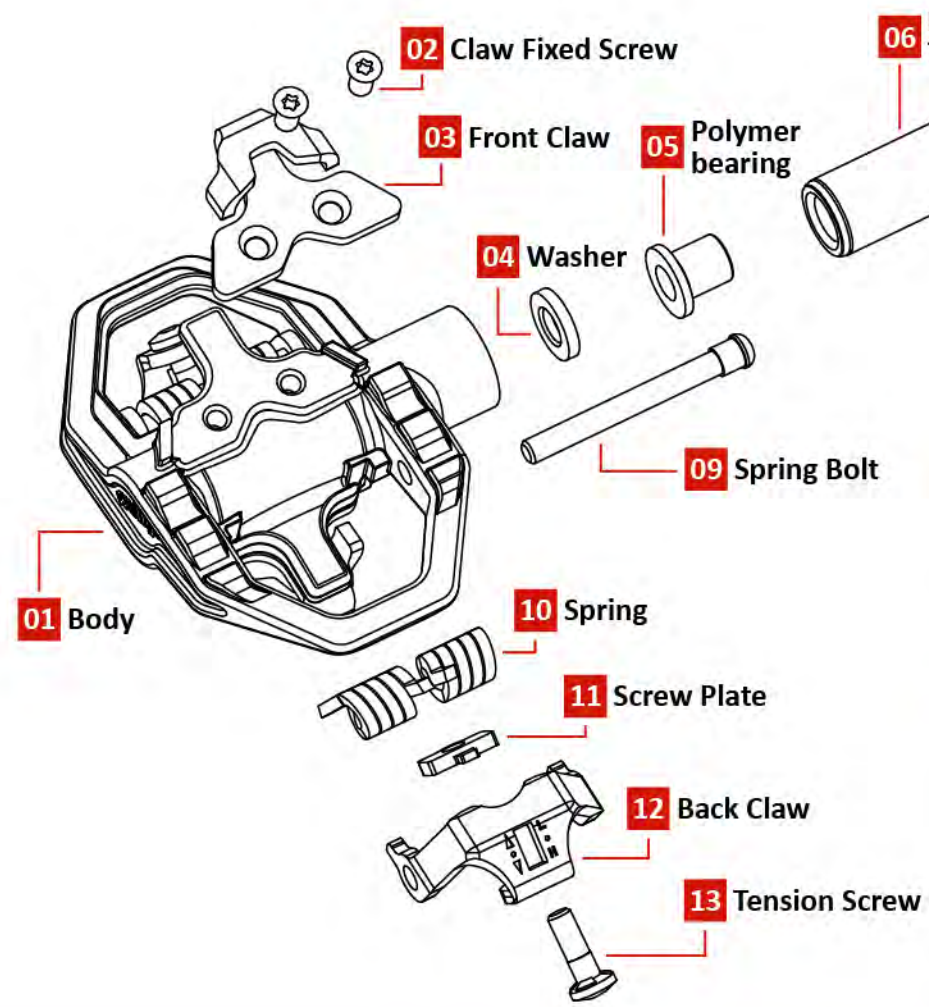

Exploded

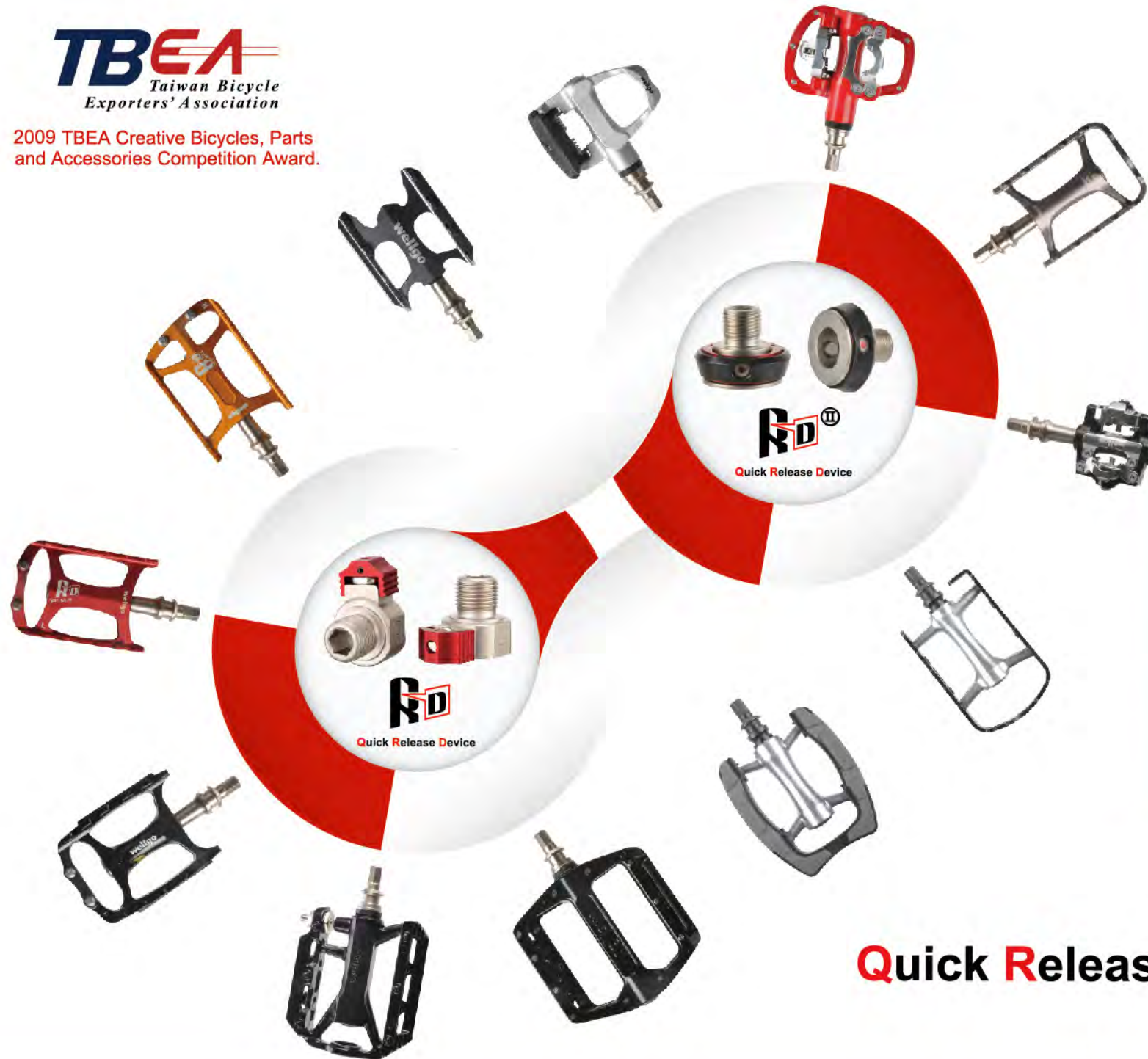

WELLGO QRD is available for many of our new and existing pedals in every category.

No tools are required and pedals can be removed with a flick of a finger.

The QRD design offers portability and additional security for bicycles when they are parked.

The ability to quickly remove the pedals without any tools save time when storing your bike in limited spaces (e.g. car, closet, box).

Quick Release Device

M279



BODY : Aluminum
SPINDLE : Cr-Mo
BEARING : Polymer bearing
SIZE : 80 * 82 * 38 mm
ORIGIN : Taiwan



FEATURES:

- ① Unique one piece design connected the front claw and the plate for better clip in and out function.
- ② With anti-loose Tension indicator construction could prevent the tension screw loose accidentally.
- ③ Cartridge sleeve design with Wellgo New 2 DU patent system offer easy replaceable ability.



R251



BODY : Aluminum
SPINDLE : Cr-Mo
BEARING : Polymer bearing
SIZE : 87 * 89 * 32 mm
ORIGIN : Taiwan



FEATURES:

- ① Dynamic Streamline body design.
- ② Wider stepping surface offers more comfortable riding. With the stainless plate composition could prevent the body from scratch while clip in and out.
- ③ Stronger spring tension design makes shoes and cleats connect tighter which will improve riding efficiency.
- ④ Cartridge sleeve design with Wellgo New 2 DU patent system offer easy replaceable ability.



NEW



M272DU



BODY : Aluminum / Barrel silver
CAGE : Aluminum
SPINDLE : Boron
BEARING : Polymer bearing
SIZE : 101 * 62.6 * 24 mm
ORIGIN : Taiwan & China



M273DU



BODY : Plastic black
CAGE : Aluminum / ED black
SPINDLE : Boron
BEARING : Polymer bearing
SIZE : 101 * 62.6 * 24 mm
ORIGIN : Taiwan & China



MG32



BODY : Magnesium / Painted
SPINDLE : Boron
BEARING : Polymer bearing
SIZE : 111.5 * 102 * 29.5 mm
OPTION : MG32A 🧤
ORIGIN : Taiwan



Polymer bearing Polymer bearing

Reasonable Price

Good value with good price

High Quality

Feels like sealed bearing



Longer life than ball bearing

High Durability

PATENT DESIGN
2DU System



MG36



BODY : Magnesium / Painted
SPINDLE : Boron
BEARING : Polymer bearing
SIZE : 111.5 * 102 * 26.2 mm
ORIGIN : Taiwan



R277



BODY : Aluminum 6061 extruded
CNC machined / Anodized

SPINDLE : Cr-Mo

BEARING : DU / Sealed

SIZE : 87 * 98.5 * 22.5 mm

OPTION : R277V R277C

ORIGIN : Taiwan



R282



BODY : Aluminum 6061 extruded
CNC machined / Anodized

SPINDLE : Cr-Mo

BEARING : DU / Sealed

SIZE : 95 * 60 * 21.6 mm

ORIGIN : Taiwan



C276



BODY : Aluminum / Barrel silver

CAGE : Aluminum / ED black

SPINDLE : Boron

BEARING : Ball bearing

SIZE : 102.5 * 70.5 * 28 mm

ORIGIN : Taiwan



M221B



BODY : Aluminum / ED black

SPINDLE : Cr-Mo

BEARING : DU / Sealed

SIZE : 88.7 * 91 * 34 mm

OPTION : Ball bearing version as M221

ORIGIN : Taiwan



M256



BODY : Aluminum 6061 extruded
CNC machined / Anodized

SPINDLE : Cr-Mo

BEARING : DU / Sealed

SIZE : 105 * 70 * 20 mm

ORIGIN : Taiwan



B257



BODY : Aluminum 6061 extruded
CNC machined / Anodized

SPINDLE : Cr-Mo

BEARING : DU / Sealed

SIZE : 103.5 * 100 * 21 mm

ORIGIN : Taiwan



B281





BODY : Aluminum 6061 extruded
CNC machined / Anodized

SPINDLE : Cr-Mo

BEARING : DU / Sealed

SIZE : 114 * 100 * 26.2 mm

OPTION : R281V  R281C 

ORIGIN : Taiwan



MG22



BODY : Magnesium / Painted

SPINDLE : Cr-Mo

BEARING : DU / Sealed

SIZE : 112 * 106 * 20.8 mm

OPTION : MG22V  MG22C 
MG22A 

ORIGIN : Taiwan



E229B



BODY : Aluminum / ED black

SPINDLE : Cr-Mo

BEARING : 3 Sealed

CLEAT : 98A or Shimano 51 compatible

SIZE : 100.5 * 79 * 34 mm

ORIGIN : Taiwan



B267



BODY : Plastic black

SPINDLE : Cr-Mo

BEARING : Ball bearing

SIZE : 106.3 * 93.9 * 27.6 mm

OPTION : Nylon with fiber as B267N

ORIGIN : Taiwan



F284



BODY : PC black
CAGE : PC black
SPINDLE : Boron
BEARING : Polymer bearing
SIZE : 104.7 * 84 * 28.2 mm
ORIGIN : Taiwan & China



B252



BODY : Aluminum 6061 extruded / Anodized
SPINDLE : Cr-Mo
BEARING : DU / Sealed
SIZE : 108 * 106 * 17.5 mm
OPTION : B252V B252C
ORIGIN : Taiwan

CP Paint

NEW Colors for 2016



Ti plate



CD-73-1



CD-87



CD-11



CA-NR-001

M250



BODY : Aluminum / ED black or painted
SPINDLE : Cr-Mo
BEARING : DU / Sealed
CLEAT : 98A or Shimano 51 compatible
SIZE : 80 * 61 * 33.5 mm
ORIGIN : Taiwan



FEATURES:

- ① Stainless plate could prevent scratches from movement.
- ② Stronger spring tension construction offers better connection between pedals and shoes which could also increasing the riding efficiency.
- ③ Tension indicator with anti-loose design.

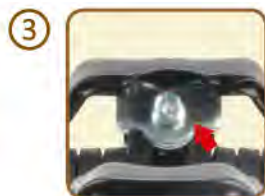

M177B

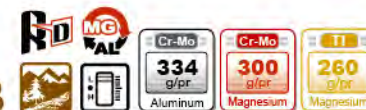

BODY : Aluminum / ED black or painted
 Magnesium / Painted
SPINDLE : Ti or Cr-Mo
BEARING : DU / Sealed
CLEAT : 98A or Shimano 51 compatible
SIZE : 84 * 64.5 * 34 mm
OPTION : Ball bearing version as M177
ORIGIN : Taiwan



M094B

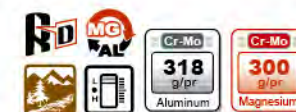

BODY : Aluminum / ED black or painted
 Magnesium / Painted
SPINDLE : Cr-Mo
BEARING : DU / Sealed
CLEAT : 98A or Shimano 51 compatible
SIZE : 80.9 * 65.3 * 33.8 mm
OPTION : Ball bearing version as M094
ORIGIN : Taiwan



W-01



BODY : Aluminum / ED black or painted
 Magnesium / Painted
SPINDLE : Ti or Cr-Mo
BEARING : DU / Sealed
CLEAT : 98A or Shimano 51 compatible
SIZE : 80.1 * 66 * 30.6 mm
ORIGIN : Taiwan



WAM-M19



BODY	: Aluminum / ED black or painted
SPINDLE	: Ti or Cr-Mo
BEARING	: DU / Sealed
CLEAT	: 98A or Shimano 51 compatible
SIZE	: 79.8 * 59.8 * 30.1 mm
ORIGIN	: Taiwan



WAM-M717



BODY	: Cr-Mo investment Painted
SPINDLE	: Ti or Cr-Mo
BEARING	: DU / Sealed
CLEAT	: 98A or Shimano 51 compatible
SIZE	: 83.6 * 57.8 * 29.3 mm
ORIGIN	: Taiwan



WPD-801



BODY	: Aluminum / ED black or painted
SPINDLE	: Ti or Cr-Mo
BEARING	: DU / Sealed
CLEAT	: 98A or Shimano 51 compatible
SIZE	: 82.4 * 66.8 * 32.8 mm
OPTION	: Magnesium version as MG-18
ORIGIN	: Taiwan



WAM-M18



BODY	: Cr-Mo investment ED black or painted
SPINDLE	: Cr-Mo
BEARING	: Ball bearing
CLEAT	: 98A or Shimano 51 compatible
SIZE	: 78.6 * 61.7 * 31.5 mm
ORIGIN	: Taiwan



WPD-823



BODY	: Aluminum / ED black or Painted
SPINDLE	: Cr-Mo
BEARING	: Ball bearing
CLEAT	: 98A or Shimano 51 compatible
SIZE	: 81.4 * 63 * 34.5 mm
ORIGIN	: Taiwan



WAM-M919



BODY	: Aluminum / ED black or Painted
SPINDLE	: Cr-Mo
BEARING	: Ball bearing
CLEAT	: 98A or Shimano 51 compatible
SIZE	: 83.8 * 58.9 * 35.5 mm
ORIGIN	: Taiwan

M151



BODY : Aluminum 6061 extruded
CNC machined / Anodized

CAGE : Aluminum / Anodized

SPINDLE : Cr-Mo

BEARING : DU / Sealed

SIZE : 107 * 60 * 22 mm

ORIGIN : Taiwan

Patent on length-changing design
MULTI FUNCTIONAL
PEDAL



Patented Pedal M384157
CN201020101444.1

★ Riders could change the pedal size to meet their needs.



M194



BODY : Aluminum 6061 extruded
CNC machined / Anodized

SPINDLE : Cr-Mo

BEARING : DU / Sealed

SIZE : 100 * 99.3 * 23 mm

OPTION : M194V M194C

ORIGIN : Taiwan



M142



BODY : Aluminum 6061 extruded
CNC machined / Anodized

SPINDLE : Cr-Mo

BEARING : DU / Sealed

SIZE : 100 * 60 * 24.5 mm

OPTION : M142V M142C

ORIGIN : Taiwan



M240



BODY : Aluminum 6061 extruded
CNC machined / Anodized

SPINDLE : Cr-Mo

BEARING : DU / Sealed

SIZE : 97 * 60 * 23 mm

OPTION : M240V M240C

ORIGIN : Taiwan



M167



BODY : Aluminum 6061 extruded
CNC machined / Anodized

SPINDLE : Cr-Mo

BEARING : DU / Sealed

SIZE : 97.5 * 62 * 22 mm

ORIGIN : Taiwan



M163



BODY : Aluminum 6061 extruded
CNC machined / Anodized

SPINDLE : Cr-Mo

BEARING : DU / Sealed

SIZE : 100.3 * 62 * 22 mm

ORIGIN : Taiwan



M079



BODY : Aluminum 6061 extruded
CNC machined / Anodized

SPINDLE : Cr-Mo

BEARING : DU / Sealed

SIZE : 100.8 * 60 * 24.4 mm

OPTION : M079V M079C

ORIGIN : Taiwan



M232



BODY : Aluminum / ED black or painted
Magnesium / Painted

SPINDLE : Cr-Mo

BEARING : DU / Sealed

SIZE : 98 * 65 * 20 mm

ORIGIN : Taiwan



M138



BODY : Aluminum / ED black or painted
Magnesium / Painted

SPINDLE : Cr-Mo

BEARING : DU / Sealed

SIZE : 102 * 68 * 29 mm

OPTION : M138V M138C

ORIGIN : Taiwan



Grease hole for easy maintenance.



Built-in reflector make the pedal looks more simple and elegant



M111



BODY : Aluminum forged / Anodized

SPINDLE : Cr-Mo

BEARING : DU / Sealed

SIZE : 99 * 61 * 18 mm

ORIGIN : Taiwan



M-20



BODY : Aluminum / Barrel silver

CAGE : Aluminum or Steel / ED black

SPINDLE : Cr-Mo

BEARING : DU / Sealed

SIZE : 101.1 * 63 * 24 mm

ORIGIN : Taiwan



M-21



BODY	: Aluminum / Barrel silver
CAGE	: Aluminum or Steel / ED black
SPINDLE	: Cr-Mo
BEARING	: Ball bearing
SIZE	: 100.7 * 63 * 24 mm
ORIGIN	: Taiwan



M149



BODY	: Aluminum / Barrel silver
CAGE	: Aluminum or Steel / ED black
SPINDLE	: Cr-Mo
BEARING	: Ball bearing
SIZE	: 97 * 63 * 24 mm
OPTION	: Sealed bearing version as M149B Available for 2DU version as M149DU
ORIGIN	: Taiwan & China



M224G



BODY	: Aluminum / ED black with CNC machined
SPINDLE	: Boron
BEARING	: Ball bearing
SIZE	: 102.5 * 66 * 25 mm
OPTION	: Sealed bearing version as M224GB Available for 2DU version as M224GDU
ORIGIN	: Taiwan & China



M248DU



BODY	: Aluminum / Barrel silver
CAGE	: Aluminum or Steel / ED black
SPINDLE	: Boron
BEARING	: Polymer bearing
SIZE	: 99.7 * 63.2 * 23.5 mm
ORIGIN	: Taiwan & China



M228



BODY	: Aluminum / Barrel silver
CAGE	: Aluminum / ED black
SPINDLE	: Boron
BEARING	: Ball bearing
SIZE	: 97.4 * 84.7 * 24.5 mm
ORIGIN	: Taiwan & China



M203



BODY	: Plastic black
CAGE	: Aluminum / ED black
SPINDLE	: Boron
BEARING	: Ball bearing
SIZE	: 110 * 89 * 31 mm
ORIGIN	: Taiwan & China



M270DU



BODY : Plastic black
CAGE : Aluminum or Steel / ED black
SPINDLE : Boron
BEARING : Polymer bearing
SIZE : 100 * 63.2 * 24 mm
ORIGIN : Taiwan

Mountable with "snap in" toe clip system



M141DU



BODY : Plastic black
CAGE : Aluminum or Steel / ED black
SPINDLE : Boron
BEARING : Polymer bearing
SIZE : 105.3 * 63 * 24 mm
OPTION : Ball bearing version as M141
ORIGIN : Taiwan & China



M095



BODY : One piece plastic black
SPINDLE : Cr-Mo
BEARING : Ball bearing
SIZE : 103 * 76 * 25.5 mm
ORIGIN : Taiwan & China



LU-895DU



BODY : One piece plastic black
SPINDLE : Boron
BEARING : Polymer bearing
SIZE : 105.5 * 86 * 23 mm
ORIGIN : Taiwan & China



M085DU



BODY : Plastic black
CAGE : Aluminum or Steel / ED black
SPINDLE : Boron
BEARING : Polymer bearing
SIZE : 99 * 63 * 24 mm
OPTION : Ball bearing version as M085
ORIGIN : Taiwan & China



M253DU



BODY : Plastic black
CAGE : Aluminum or Steel / ED black
SPINDLE : Boron
BEARING : Polymer bearing
SIZE : 103 * 76.3 * 34.3 mm
ORIGIN : Taiwan & China

Mountable with "snap in" toe clip system



M113



BODY : One piece plastic black
SPINDLE : Boron or Cr-Mo
BEARING : Ball bearing
SIZE : 103.5 * 78 * 25.5 mm
ORIGIN : Taiwan & China

R226



BODY : Aluminum / Barrel silver or painted
SPINDLE : Cr-Mo
BEARING : DU / Sealed
CLEAT : 98A or Shimano 51 compatible
SIZE : 81.5 * 84.5 * 29.5 mm
ORIGIN : Taiwan



FEATURES:

- ① Wider stepping surface provide more comfort while riding.
- ② Stronger spring tension construction offers better connection between pedals and shoes which could also increasing the riding efficiency.
- ③ Tension indicator with anti-loose design.



R168

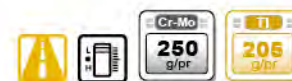

BODY : Engineering plastic
SPINDLE : Cr-Mo or Ti
BEARING : 3 Sealed bearing
CLEAT : RC7A/ B/ C compatible
SIZE : 89.8 * 81 * 32.5 mm
ORIGIN : Taiwan



Tension indicator
 Stainless plate prevents scratches from movement.

FEATURES:

- ① Using ultra light weight Engineering Plastics for pedal body.
- ② One piece body forming with stainless plate providing smoother movement and prevent scratches.
- ③ Wider and larger step surface makes riding comfortable.
- ④ Using 3 bearings for better function and easy for replacement and maintenance.
- ⑤ Tension indicator with anti-loose design.



POSI-R168

WELLGO INNOVATION

Auto Reset Positioner

By using the magnet element, the ARP helps to control the clipless step entry side to the as riders wish.

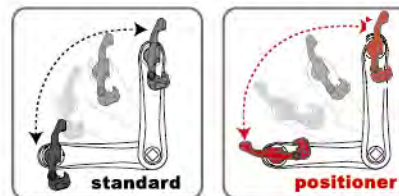

By using ARP, riders could easily clip the shoes into the pedal without looking at the pedal to reduce possible injury for missing the engagement.



TBEA
 Taiwan Bicycle
 Exporters' Association
 2011 TBEA Creative Bicycles,
 Parts and Accessories
 Competition Award.

R191B



BODY : Aluminum / Barrel silver with kraton top
SPINDLE : Cr-Mo or Ti
BEARING : DU / Sealed
CLEAT : 98A or Shimano 51 compatible
SIZE : 90 * 87.5 * 32 mm
OPTION : Ball bearing version as R191
ORIGIN : Taiwan



R120B



BODY : Aluminum / Barrel silver or painted
SPINDLE : Cr-Mo
BEARING : DU / Sealed
CLEAT : 98A or Shimano 51 compatible
SIZE : 85 * 84 * 33.5 mm
OPTION : Ball bearing version
 as R120 with mold pin
 R120BA R120BV R120BC
ORIGIN : Taiwan



WR003



BODY : Aluminum / ED black or painted
SPINDLE : Cr-Mo
BEARING : DU / Sealed
SIZE : 98A or Shimano 51 compatible
OPTION : 82 * 65 * 28 mm
ORIGIN : Taiwan



W41



BODY : Cr-Mo investment
 ED black or painted
SPINDLE : Cr-Mo
BEARING : Ball bearing
CLEAT : 98A or Shimano 51 compatible
SIZE : 78.6 * 54.2 * 24.3 mm
ORIGIN : Taiwan



MG-8



BODY : Magnesium / Painted
SPINDLE : Cr-Mo or Ti
BEARING : DU / Sealed
CLEAT : 98A or Shimano 51 compatible
SIZE : 79.8 * 64.8 * 27.8 mm
ORIGIN : Taiwan



R096B



BODY : Aluminum / ED black or painted
Magnesium / Painted

SPINDLE : Cr-Mo or Ti

BEARING : Needle / Sealed

CLEAT : RC7A/ B/ C compatible

SIZE : 81 * 87 * 33 mm

OPTION : Ball bearing version as R096

ORIGIN : Taiwan



MG-9



BODY : Magnesium / Painted

SPINDLE : Cr-Mo or Ti

BEARING : DU / Sealed

CLEAT : RC-5 / RC-6,
LOOK "ARC" compatible

SIZE : 85.2 * 95.8 * 34.2 mm

ORIGIN : Taiwan



W40B



BODY : Aluminum / ED black or painted

SPINDLE : Cr-Mo

BEARING : DU / Sealed

CLEAT : RC-5 / RC-6
LOOK "ARC" compatible

SIZE : 85 * 92 * 33 mm

OPTION : Ball bearing version as W40

ORIGIN : Taiwan

W-44B



BODY : Aluminum / ED black or painted
Magnesium / Painted color

SPINDLE : Cr-Mo

BEARING : DU / Sealed

CLEAT : 98A or Shimano 51 compatible

SIZE : 82.8 * 76 * 46.8 mm

OPTION : Ball bearing version as W44

ORIGIN : Taiwan



W-43



BODY : Aluminum/ Barrel silver or painted

SPINDLE : Cr-Mo

BEARING : Ball bearing

CLEAT : 98A or Shimano 51 compatible

SIZE : 90 * 100 * 32.5 mm

ORIGIN : Taiwan





R146



BODY : Aluminum / ED black or painted
Magnesium / Painted color

SPINDLE : Cr-Mo

BEARING : DU / Sealed

SIZE : 85 * 86 * 32 mm

OPTION : R146A R146V R146C

ORIGIN : Taiwan



LU-C16



BODY : Aluminum 6061 extruded
CNC machined / Anodized

SPINDLE : Cr-Mo or Ti

BEARING : DU / Sealed

SIZE : 92.9 * 61.5 * 22 mm

ORIGIN : Taiwan



R074



BODY : Aluminum 6061 extruded
CNC machined / Anodized

SPINDLE : Cr-Mo

BEARING : DU / Sealed

SIZE : 91.5 * 60 * 21.6 mm

ORIGIN : Taiwan



R110B



BODY : Aluminum / Barrel silver

CAGE : Aluminum / ED black

SPINDLE : Cr-Mo

BEARING : DU / Sealed

SIZE : 88 * 68.6 * 29 mm

OPTION : Ball bearing version as R110

ORIGIN : Taiwan



R126



BODY : Aluminum / Barrel silver

CAGE : Aluminum or Steel / ED black

SPINDLE : Cr-Mo

BEARING : Ball bearing

SIZE : 104.6 * 63 * 24 mm

OPTION : Sealed bearing version as R126B
Available for 2DU version as R126DU

ORIGIN : Taiwan & China



R183



BODY : Aluminum / Barrel silver or ED black

SPINDLE : Cr-Mo

BEARING : Ball bearing

SIZE : 107 * 63.5 * 30 mm

OPTION : Sealed bearing version as R183B

ORIGIN : Taiwan



R200



BODY	: Aluminum / Barrel silver
CAGE	: Aluminum or Steel / ED black
SPINDLE	: Cr-Mo
BEARING	: Ball bearing
SIZE	: 99 * 63.2 * 22 mm
OPTION	: Sealed bearing version as R200B Available for 2DU version as R200DU
ORIGIN	: Taiwan & China



R199



BODY	: Plastic black
CAGE	: Aluminum or Steel / ED black
SPINDLE	: Cr-Mo
BEARING	: Ball bearing
SIZE	: 99 * 63.2 * 22 mm
OPTION	: Available for 2DU version as R199DU
ORIGIN	: Taiwan & China



R261DU



BODY	: Plastic black
CAGE	: Aluminum or Steel / ED black
SPINDLE	: Boron
BEARING	: Polymer bearing
SIZE	: 104.2 * 63.2 * 23.8 mm
ORIGIN	: Taiwan & China



R262DU



BODY	: Plastic black
CAGE	: Aluminum or Steel / ED black
SPINDLE	: Boron
BEARING	: Polymer bearing
SIZE	: 100.1 * 63.2 * 22 mm
ORIGIN	: Taiwan & China



R125



BODY	: Plastic black
CAGE	: Aluminum or Steel / ED black
SPINDLE	: Cr-Mo
BEARING	: Ball bearing
SIZE	: 104.6 * 63.2 * 24 mm
OPTION	: Available for 2DU version as R125DU
ORIGIN	: Taiwan & China

Mountable with "snap in"
toe clip system



R090



BODY	: One piece plastic black
SPINDLE	: Cr-Mo
BEARING	: Ball bearing
SIZE	: 99 * 79.8 * 24 mm
ORIGIN	: Taiwan



R025B



BODY : Aluminum / Barrel silver
CAGE : Aluminum / ED black
SPINDLE : Cr-Mo
BEARING : DU / Sealed
SIZE : 90.1 * 64.8 * 27.7 mm
OPTION : ball bearing version as R025
ORIGIN : Taiwan

- * Mountable with steel toe clip and strap.
- * Leather strap available in black, brown and white.
- * 2 pieces cut cage design offers premium ground clearance.



W-5 Single leather strap



White



Brown



Black

W-6 Double leather strap



White



Brown



Black

MT-16

Steel toe-clip with CP finished.
 Size: M / L / XL



MT-20

Steel toe-clip with CP finished.
 Size: M / L



MT-21

Steel toe-clip with CP finished.
 Size: M / L



R104B



BODY : Aluminum / Barrel silver
CAGE : Aluminum / ED black
SPINDLE : Cr-Mo
BEARING : DU / Sealed
SIZE : 104 * 65.6 * 30.8 mm
OPTION : ball bearing version as R104
ORIGIN : Taiwan

- * One piece classic aluminum cage shape.
- * Fashion but also elegant.
- * Mountable with steel toe clip and leather strap.



OTHER OPTIONS



Brown

Black

Blue

Purple

Red

Yellow

Green

Pewter

Tangerine

QRDII-C231B

LOCKING PEDAL



BODY	: Aluminum / ED black or painted Magnesium / Painted
SPINDLE	: Cr-Mo
BEARING	: DU / Sealed
SIZE	: 102 * 100 * 26 mm
ORIGIN	: Taiwan

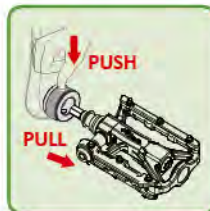

front wheel



rear wheel



The pedal could be locking at front or rear spoke as a locker

FEATURES:

To solve the noising sound while riding on bumpy road and the inconvenience for carry locks outdoor, wellgo locking pedal has been connected the pedal and the lock. It offers the rider to easily remove the pedal and put it onto the spoke as a lock. Locking pedal design is compatible to all bikes.



Quick Release Device

C176B



BODY	: Aluminum / Barrel silver or ED black
CAGE	: Aluminum / ED black or anodized
SPINDLE	: Cr-Mo
BEARING	: DU / Sealed
CLEAT	: 98A or Shimano 51 compatible
SIZE	: 104 * 63.2 * 28 mm
OPTION	: Ball bearing version as C176
ORIGIN	: Taiwan



FEATURES:

The waving linear design on the body makes the design more vitality and out of the conventional concept, the extended stepping width surface also improves the riding comfort. The tension screw could be adjusted as per rider's demands and the indicator design gives awareness to the adjusting stages. In addition, the outer cage design also provides better traction while riding.

C002B



BODY	: Aluminum / Barrel silver
CAGE	: Aluminum / ED black or anodized
SPINDLE	: Cr-Mo
BEARING	: DU / Sealed
CLEAT	: 98A or Shimano 51 compatible
SIZE	: 101.7 * 65.4 * 29.8 mm
OPTION	: Ball bearing version as C002
ORIGIN	: Taiwan



WPD-M17C



BODY	: Aluminum / Barrel silver
CAGE	: Aluminum / ED black or anodized
SPINDLE	: Cr-Mo
BEARING	: DU / Sealed
CLEAT	: 98A or Shimano 51 compatible
SIZE	: 100.8 * 65.2 * 27.2 mm
ORIGIN	: Taiwan

WPD-95B



BODY	: Aluminum / Barrel silver
CAGE	: Aluminum / ED black or anodized
SPINDLE	: Cr-Mo
BEARING	: DU / Sealed
CLEAT	: 98A or Shimano 51 compatible
SIZE	: 101.7 * 65.4 * 29.8 mm
ORIGIN	: Taiwan



C234



BODY	: Aluminum 6061 extruded / Anodized
SPINDLE	: Cr-Mo
BEARING	: DU / Sealed
SIZE	: 96 * 78 * 20.5 mm
OPTION	: C234V C234C
ORIGIN	: Taiwan



C238



BODY : Aluminum 6061 extruded
CNC machined / Anodized

CAGE : Aluminum / Anodized

SPINDLE : Cr-Mo

BEARING : DU / Sealed

SIZE : 110 * 67.2 * 23 mm

OPTION : C238V C238C

ORIGIN : Taiwan



Grease



CLOSED



OPEN AS THE STAND



C271



BODY : Aluminum 6061 extruded
CNC machined / Anodized

SPINDLE : Cr-Mo

BEARING : DU / Sealed

SIZE : 95.5 * 78 * 24.5 mm

OPTION : C271V C271C

ORIGIN : Taiwan



C266



BODY : Aluminum 6061 extruded
CNC machined / Anodized

SPINDLE : Cr-Mo

BEARING : DU / Sealed

SIZE : 90 * 78 * 25 mm

OPTION : C266V C266C

ORIGIN : Taiwan



C260



BODY : Aluminum 6061 extruded
CNC machined / Anodized

SPINDLE : Cr-Mo or Ti

BEARING : DU / Sealed

SIZE : 100 * 82 * 24 mm

OPTION : C260V C260C

ORIGIN : Taiwan



C237



BODY : Aluminum Forged
CNC machined / Anodized

SPINDLE : Cr-Mo

BEARING : DU / Sealed

SIZE : 98.6 * 74 * 20.8 mm

OPTION : C237V C237C

ORIGIN : Taiwan



C241



BODY : Aluminum 6061 extruded
CNC machined / Anodized

SPINDLE : Cr-Mo

BEARING : DU / Sealed

SIZE : 92.5 * 78 * 24.8 mm

OPTION : C241V C241C

ORIGIN : Taiwan



C161



BODY : Aluminum 6061 extruded
CNC machined / Anodized

SPINDLE : Cr-Mo

BEARING : DU / Sealed

SIZE : 108 * 78 * 26 mm

OPTION : C161V C161C

ORIGIN : Taiwan



C165



BODY : Aluminum 6061 extruded
CNC machined / Anodized

SPINDLE : Cr-Mo

BEARING : DU / Sealed

SIZE : 92.5 * 78 * 25 mm

OPTION : C165V C165C

ORIGIN : Taiwan



C006



BODY : Aluminum 6061 extruded
CNC machined / Anodized

SPINDLE : Cr-Mo

BEARING : DU / Sealed

SIZE : 95 * 61.5 * 22.9 mm

ORIGIN : Taiwan



C254DU



BODY : Aluminum with Sand Paper

SPINDLE : Boron

BEARING : Polymer bearing

SIZE : 106 * 75 * 27 mm

OPTION : Sealed bearing version as C254B

ORIGIN : Taiwan



C280DU



BODY : Aluminum / Barrel silver

SPINDLE : Boron

BEARING : Polymer bearing

SIZE : 104.9 * 77.6 * 24 mm

ORIGIN : Taiwan & China



C210



BODY : Aluminum / Barrel silver

SPINDLE : Boron

BEARING : Ball bearing

SIZE : 102 * 75 * 25 mm

OPTION : Sealed bearing version as C210B

ORIGIN : Taiwan & China



C227DU



BODY : Aluminum / ED black or painted

SPINDLE : Boron

BEARING : Polymer bearing

SIZE : 99 * 84 * 26.5 mm

OPTION : Sealed bearing version as C227B

ORIGIN : Taiwan



C236



BODY : Aluminum / ED black or painted
Magnesium / Painted

SPINDLE : Cr-Mo

BEARING : DU / Sealed

SIZE : 92.5 * 78 * 29 mm

OPTION : C236V C236C

ORIGIN : Taiwan



C089B



BODY : Aluminum / Barrel silver

CAGE : Aluminum / ED black

SPINDLE : Cr-Mo

BEARING : DU / Sealed

SIZE : 86.7 * 63.2 * 20 mm

OPTION : Ball bearing version as C089

ORIGIN : Taiwan



LU-C27G



BODY : Aluminum / ED black with
CNC machined

SPINDLE : Cr-Mo

BEARING : Ball bearing

SIZE : 101.5 * 63.3 * 23.3 mm

OPTION : Sealed bearing as LU-C27GB
Cage without machined as LU-C27

ORIGIN : Taiwan



C128



BODY : Aluminum / Barrel silver

CAGE : Aluminum or Steel / ED black

SPINDLE : Cr-Mo

BEARING : Ball bearing

SIZE : 106.3 * 63 * 24 mm

OPTION : Sealed bearing version as C128B
Available for 2DU version as C128DU

ORIGIN : Taiwan & China



C201



BODY : Aluminum / Barrel silver

CAGE : Aluminum / ED black

SPINDLE : Boron

BEARING : Ball bearing

SIZE : 110 * 80 * 25 mm

OPTION : Sealed bearing version as C201B

ORIGIN : Taiwan & China



C202



BODY : Aluminum / Barrel silver
CAGE : Aluminum / ED black
SPINDLE : Boron
BEARING : Ball bearing
SIZE : 110 * 80 * 25 mm
OPTION : Sealed bearing version as C202B
ORIGIN : Taiwan & China



C175



BODY : Plastic black
CAGE : Aluminum / ED black
SPINDLE : Boron
BEARING : Ball bearing
SIZE : 110 * 80 * 25 mm
ORIGIN : Taiwan & China



C127



BODY : Plastic black
CAGE : Aluminum or steel / ED black
SPINDLE : Cr-Mo
BEARING : Ball bearing
SIZE : 106.3 * 63 * 24 mm
OPTION : 2DU version as C127DU
ORIGIN : Taiwan & China



C174



BODY : Plastic black
CAGE : Aluminum / ED black
SPINDLE : Boron
BEARING : Ball bearing
SIZE : 110 * 80 * 25 mm
ORIGIN : Taiwan & China



C220



BODY : Aluminum / Barrel silver with
 kraton top
SPINDLE : Cr-Mo
BEARING : Ball bearing
SIZE : 108 * 82 * 28 mm
OPTION : Sealed bearing version as C220B
 2DU version as C220DU
ORIGIN : Taiwan & China



C32B



BODY : Aluminum / Barrel silver with
kraton top

SPINDLE : Cr-Mo

BEARING : DU / Sealed

SIZE : 102.9 * 69.6 * 24.2 mm

OPTION : Ball bearing version as C32

ORIGIN : Taiwan



C098



BODY : Aluminum body with plastic
cage overmolded kraton

SPINDLE : Cr-Mo

BEARING : Ball bearing

SIZE : 103 * 79.5 * 24 mm

OPTION : Sealed bearing version as C098B

ORIGIN : Taiwan



C122



BODY : Aluminum / Barrel silver with
kraton top

SPINDLE : Cr-Mo

BEARING : Ball bearing

SIZE : 100 * 83 * 25 mm

OPTION : Sealed bearing version as C122B

ORIGIN : Taiwan



C169



BODY : Aluminum / Barrel silver with
kraton top

SPINDLE : Cr-Mo

BEARING : Ball bearing

SIZE : 105 * 80 * 27 mm

OPTION : Sealed bearing version as C169B
2DU version as C169DU

ORIGIN : Taiwan & China



C016



BODY : Aluminum / Barrel silver with
kraton top

SPINDLE : Cr-Mo

BEARING : Ball bearing

SIZE : 106 * 91 * 30 mm

OPTION : Sealed bearing version as C016B

ORIGIN : Taiwan



C172DU



BODY : Plastic with kraton top
SPINDLE : Boron
BEARING : Polymer bearing
SIZE : 106.5 * 81 * 24.8 mm
OPTION : Ball bearing version as C172
ORIGIN : Taiwan & China



C097



BODY : Plastic with kraton top
SPINDLE : Cr-Mo
BEARING : Ball bearing
SIZE : 103 * 79.5 * 24 mm
ORIGIN : Taiwan



C160



BODY : Plastic with kraton top
SPINDLE : Cr-Mo
BEARING : Ball bearing
SIZE : 120 x 80 x 27 mm
ORIGIN : Taiwan



C246DU



BODY : One piece plastic black
SPINDLE : Boron
BEARING : Polymer bearing
SIZE : 106.3 * 80.9 * 23.8 mm
ORIGIN : Taiwan & China



C112



BODY : Plastic black
SPINDLE : Cr-Mo
BEARING : Ball bearing
SIZE : 112 * 75 * 27 mm
ORIGIN : Taiwan & China



C283



BODY : Plastic black
SPINDLE : Steel
BEARING : Ball-less
SIZE : 88.5 * 67.7 * 24.8 mm
ORIGIN : Taiwan & China



B252-AL



BODY : Aluminum 6061 extruded /
Anodized

SPINDLE : Cr-Mo

BEARING : DU / Sealed

SIZE : 108 * 106 * 17.5 mm

OPTION : B252V-AL B252C-AL

ORIGIN : Taiwan



MG6-AL



BODY : Aluminum / ED black or painted

SPINDLE : Cr-Mo

BEARING : DU / Sealed

SIZE : 112 * 106 * 20.8 mm

OPTION : MG6V-AL MG6C-AL
MG6A-AL

ORIGIN : Taiwan



MG3



BODY : Magnesium / Painted

SPINDLE : Boron

BEARING : Polymer bearing

SIZE : 111.5 * 102 * 27.6 mm

OPTION : Aluminum version as B249DU
with mold pin (TWN & CHINA)

ORIGIN : Taiwan



MG35YR



BODY : Magnesium / Painted

SPINDLE : Cr-Mo

BEARING : DU / Sealed

SIZE : 112 * 106 * 20.8 mm

OPTION : MG35YV MG35YC
MG35YA

ORIGIN : Taiwan

B249DU



PLATFORM



B258



BODY : Aluminum Forged
CNC machined / Anodized

SPINDLE : Cr-Mo

BEARING : DU / Sealed

SIZE : 114.5 * 99 * 10 mm

ORIGIN : Taiwan



W-70



BODY : Aluminum / ED black
CNC machined

SPINDLE : Cr-Mo

BEARING : DU / Sealed

CLEAT : 98A or Shimano 51 compatible

SIZE : 104 * 89 * 30.1 mm

ORIGIN : Taiwan



B181



BODY : Aluminum Forged
CNC machined / Anodized

SPINDLE : Cr-Mo

BEARING : DU / Sealed

SIZE : 115 * 102 * 10 mm

OPTION : B181R B181V

ORIGIN : Taiwan



WAM-D10



BODY : Magnesium / Painted color

SPINDLE : Cr-Mo

BEARING : Needle / DU / Sealed

CLEAT : 98A or Shimano 51 compatible

SIZE : 109.1 * 94.7 * 33.8 mm

ORIGIN : Taiwan



B263



BODY : Aluminum 6061 extruded
CNC machined / Anodized

SPINDLE : Cr-Mo

BEARING : DU / Sealed

SIZE : 112 * 101.5 * 20 mm

OPTION : B263V B263C

B263R

ORIGIN : Taiwan



B219



BODY : Aluminum 6061 extruded
CNC machined / Anodized

SPINDLE : Cr-Mo

BEARING : DU / Sealed

SIZE : 108.7 * 106.7 * 25 mm

OPTION : B219R B219V

B219C

ORIGIN : Taiwan



B190



BODY : Aluminum 6061 extruded
CNC machined / Anodized

SPINDLE : Cr-Mo

BEARING : DU / Sealed

SIZE : 102 * 103.8 * 19.8 mm

OPTION : B190V B190C
B190A

ORIGIN : Taiwan



B185



BODY : Aluminum 6061 extruded
CNC machined / Anodized

SPINDLE : Cr-Mo

BEARING : DU / Sealed

SIZE : 111 * 100 * 27 mm

OPTION : B185R B185V

ORIGIN : Taiwan



B184



BODY : Aluminum 6061 extruded
CNC machined / Anodized

SPINDLE : Cr-Mo

BEARING : DU / Sealed

SIZE : 105.5 * 100 * 27 mm

OPTION : B184R B184V

ORIGIN : Taiwan



B164



BODY : Aluminum 6061 extruded
CNC machined / Anodized

SPINDLE : Cr-Mo

BEARING : DU / Sealed

SIZE : 104 * 100 * 26 mm

OPTION : B164V B164C

ORIGIN : Taiwan



B150



BODY : Aluminum 6061 extruded
CNC machined / Anodized

SPINDLE : Cr-Mo

BEARING : DU / Sealed

SIZE : 104.5 * 100 * 26 mm

OPTION : B150V B150C

ORIGIN : Taiwan



B143



BODY : Aluminum 6061 extruded
CNC machined / Anodized

SPINDLE : Cr-Mo

BEARING : DU / Sealed

SIZE : 107.3 * 100 * 26.1 mm

OPTION : B143V B143C

ORIGIN : Taiwan



B114



BODY : Aluminum 6061 extruded
CNC machined / Anodized

SPINDLE : Cr-Mo

BEARING : DU / Sealed

SIZE : 107.3 * 100 * 25.9 mm

OPTION : B114V B114C

ORIGIN : Taiwan



B124



BODY : Aluminum 6061 extruded
CNC machined / Anodized

SPINDLE : Cr-Mo

BEARING : DU / Sealed

SIZE : 107.3 * 100 * 25.7 mm

OPTION : B124V B124C

ORIGIN : Taiwan



B144



BODY : Aluminum 6061 extruded
CNC machined / Anodized

SPINDLE : Cr-Mo

BEARING : DU / Sealed

SIZE : 104 * 100 * 26.6 mm

OPTION : B144V B144C

ORIGIN : Taiwan



B131



BODY : Aluminum 6061 extruded
CNC machined / Anodized

SPINDLE : Cr-Mo

BEARING : DU / Sealed

SIZE : 104 * 100 * 25.9 mm

OPTION : B131V B131C

ORIGIN : Taiwan



B132



BODY : Aluminum 6061 extruded
CNC machined / Anodized

SPINDLE : Cr-Mo

BEARING : DU / Sealed

SIZE : 103.5 * 100 * 25 mm

OPTION : B132V B132C

ORIGIN : Taiwan



B103



BODY : Aluminum 6061 extruded
CNC machined / Anodized

SPINDLE : Cr-Mo

BEARING : DU / Sealed

SIZE : 107 * 100 * 26.3 mm

OPTION : B103V B103C

ORIGIN : Taiwan



B030



BODY : Aluminum 6061 extruded
CNC machined / Anodized

SPINDLE : Cr-Mo

BEARING : DU / Sealed

SIZE : 109.5 * 100 * 21.9 mm

OPTION : B030R B030V
B030C

ORIGIN : Taiwan



B245



BODY : Aluminum / ED black or Painted
Magnesium / Painted

SPINDLE : Cr-Mo

BEARING : DU / Sealed

SIZE : 112 * 100 * 29 mm

OPTION : B245R B245V
B245C

ORIGIN : Taiwan



B065



BODY : Aluminum 6061 extruded
CNC machined / Anodized

SPINDLE : Cr-Mo

BEARING : DU / Sealed

SIZE : 104.5 * 100 * 24 mm

OPTION : B065R B065V
B065C

ORIGIN : Taiwan



B233



BODY : Aluminum / ED black or Painted
Magnesium / Painted

SPINDLE : Cr-Mo

BEARING : DU / Sealed

SIZE : 110.5 * 100 * 26 mm

OPTION : B233R B233V
B233C

ORIGIN : Taiwan



B087B



BODY : Aluminum / ED black or painted
Magnesium / Painted

SPINDLE : Cr-Mo

BEARING : DU / Sealed

SIZE : 109 * 100.5 * 26 mm

OPTION : Ball bearing as B087 with mold pin
B087U B087R

B087V B087C

2DU version as B087DU with mold pin

ORIGIN : Taiwan & China



MG-1



BODY : Magnesium / Painted

SPINDLE : Cr-Mo

BEARING : DU / Sealed

SIZE : 114.6 * 106.2 * 30.8 mm

OPTION : MG-1R MG-1V
MG-1C

ORIGIN : Taiwan

PLATFORM



LU-A52



BODY : Aluminum / ED black or painted
Magnesium MG52 / Painted

SPINDLE : Cr-Mo

BEARING : DU / Sealed

SIZE : 109 * 106 * 25 mm

OPTION : Ball bearing version as LU-A52A

ORIGIN : Taiwan



B102B



BODY : Aluminum / ED black or painted
Magnesium / Painted

SPINDLE : Cr-Mo

BEARING : DU / Sealed

SIZE : 113.5 * 102 * 27.6 mm

OPTION : Ball bearing as B102 with mold pin

B102U B102R

B102V B102C

ORIGIN : Taiwan



B155



BODY : Aluminum / ED black or painted
Magnesium / Painted

SPINDLE : Cr-Mo

BEARING : Ball Bearing

SIZE : 108.5 * 100 * 28 mm

OPTION : Sealed bearing version as B155B

B155U B155R

B155V B155C

ORIGIN : Taiwan



B121



BODY : Aluminum / Barrel silver or ED black
Magnesium / Painted

SPINDLE : Cr-Mo

BEARING : Ball Bearing

SIZE : 112 * 100 * 30.5 mm

OPTION : Sealed bearing version as B121B

B121R B121V B121C

ORIGIN : Taiwan



B133



BODY : Aluminum / Barrel silver or ED black
Magnesium / Painted

SPINDLE : Cr-Mo

BEARING : Ball Bearing

SIZE : 105.4 * 90.2 * 28 mm

OPTION : Sealed bearing version as B133B

B133U B133R

B133V B133C

ORIGIN : Taiwan



B123



BODY : One piece plastic black

SPINDLE : Cr-Mo

BEARING : Ball bearing

SIZE : 111 * 98.7 * 26.5 mm

ORIGIN : Taiwan



186C

B223BP



- BODY** : PC translucent color
- SPINDLE** : Cr-Mo
- BEARING** : DU / Sealed
- SIZE** : 111 * 100 * 27 mm
- OPTION** : Ball Bearing version as B223P
- ORIGIN** : Taiwan



802C

B223BN



- BODY** : Nylon with Fiber
- SPINDLE** : Cr-Mo
- BEARING** : DU / Sealed
- SIZE** : 111 * 100 * 27 mm
- OPTION** : Ball Bearing version as B223N
- ORIGIN** : Taiwan

COLOR OPTION



PC
(Strap mountable)

STRAP

W8



Rainbow



Reflective



Black



Camouflage

W12



Black



Yellow



Purple



Grey



Red



Green



Blue



Fuchsia



White



Water Proof Cover

PLATFORM



PC

B109P



Cr-Mo 370 g/pr B109P	Cr-Mo 398 g/pr B109N	Cr-Mo 330 g/pr B109
-------------------------------	-------------------------------	------------------------------

BODY : PC Translucent color
SPINDLE : Cr-Mo
BEARING : Ball bearing
SIZE : 111 * 102.5 * 30 mm
OPTION : Nylon with fiber as B109N
 Plastic as B109
ORIGIN : Taiwan



PP

B152



Cr-Mo 348 g/pr B152P	Cr-Mo 366 g/pr B152N	Cr-Mo 314 g/pr B152
-------------------------------	-------------------------------	------------------------------

BODY : Plastic
SPINDLE : Cr-Mo
BEARING : Ball bearing
SIZE : 101 * 90 * 27.5 mm
OPTION : PC translucent color as B152P
 Nylon with fiber as B152N
ORIGIN : Taiwan



B197



Cr-Mo 300 g/pr B197P	Cr-Mo 320 g/pr B197N	Cr-Mo 270 g/pr B197
-------------------------------	-------------------------------	------------------------------

BODY : Plastic black
SPINDLE : Cr-Mo
BEARING : Ball bearing
SIZE : 106 * 90 * 31.7 mm
OPTION : Nylon with Fiber as B197N
 PC Translucent color as B197P
ORIGIN : Taiwan & China



CLEAR

B107P



Cr-Mo 374 g/pr

BODY : PC Translucent color
SPINDLE : Cr-Mo
BEARING : Ball bearing
SIZE : 112 * 102.4 * 28.4 mm
ORIGIN : Taiwan



154C

B107N



Cr-Mo 386 g/pr

BODY : Nylon with fiber
SPINDLE : Cr-Mo
BEARING : Ball bearing
SIZE : 112 * 102.4 * 28.4 mm
OPTION : Available with Reflector design
ORIGIN : Taiwan



E148B



BODY	: Aluminum / ED black
SPINDLE	: Cr-Mo
BEARING	: 3 Sealed
CLEAT	: 98A or Shimano 51 compatible RC7A / B / C or LOOK "KEO" cleat compatible
SIZE	: 99 * 87.5 * 43.5 mm
OPTION	: Ball bearing version as E148
ORIGIN	: Taiwan



Toe Clip adapter : 0°

- 1** Push down the buckle

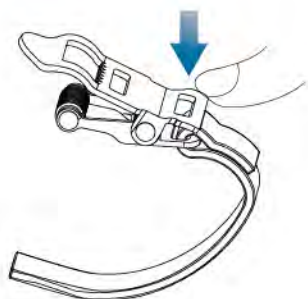

- 2** Have the strap through the buckle



- 3** Release the buckle



- 4** Have the strap go through the upper hole of the buckle to hold the strap

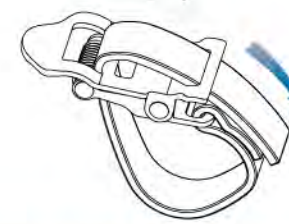

E179



BODY	: Aluminum / Barrel silver
CAGE	: Steel / ED black
SPINDLE	: Cr-Mo
BEARING	: Ball bearing
SIZE	: 113 * 62.6 * 30 mm
OPTION	: Toe clip & strap mountable
ORIGIN	: Taiwan



EX-13



BODY	: Plastic black with Pu Strap
SPINDLE	: Boron
BEARING	: Ball bearing
SIZE	: 115.2 * 130.9 * 51 mm
ORIGIN	: Taiwan



WPD-E003B



Cr-Mo
774
g/pr
Aluminum

BODY : Aluminum / ED black
SPINDLE : Cr-Mo
BEARING : 3 Sealed
CLEAT : 98A or Shimano 51 compatible
SIZE : 102.4 * 72.4 * 34.9 mm
OPTION : W/O QBS as E003B
 Ball bearing version as WPD-E003
ORIGIN : Taiwan



E003B



Cr-Mo
672
g/pr
Aluminum

BODY : Aluminum / ED black
SPINDLE : Cr-Mo
BEARING : 3 Sealed
CLEAT : 98A or Shimano 51 compatible
SIZE : 102.4 * 72.4 * 34.9 mm
OPTION : W/QBS as WPD-E003B
 Ball bearing version as E003
ORIGIN : Taiwan



WPD-E14B



Cr-Mo
832
g/pr
Aluminum

BODY : Aluminum barrel silver
 with kraton top
SPINDLE : Cr-Mo
BEARING : DU / Needle / Sealed
CLEAT : 98A or Shimano 51 compatible
SIZE : 109 * 80.2 * 34.8 mm
OPTION : W/O QBS as E14B
 Ball bearing version as WPD-E14
ORIGIN : Taiwan



E14B



Cr-Mo
728
g/pr
Aluminum

BODY : Aluminum barrel silver
 with kraton top
SPINDLE : Cr-Mo
BEARING : DU / Needle / Sealed
CLEAT : 98A or Shimano 51 compatible
SIZE : 109 * 80.2 * 34.8 mm
OPTION : W/QBS as WPD-E14B
 Ball version as E14
ORIGIN : Taiwan



F265



BODY	: Aluminum / ED black or barrel silver
CAGE	: Aluminum / ED black or barrel silver
SPINDLE	: Boron
BEARING	: Polymer bearing
SIZE	: 104.7 * 84 * 28.2 mm
ORIGIN	: Taiwan & China



F268



BODY	: Aluminum / ED black or barrel silver
CAGE	: PC black or translucent color
SPINDLE	: Boron
BEARING	: Polymer bearing
SIZE	: 104.7 * 84 * 28.2 mm
ORIGIN	: Taiwan & China



F278



BODY	: PC black
CAGE	: Aluminum / ED black or barrel silver
SPINDLE	: Boron
BEARING	: Polymer bearing
SIZE	: 104.7 * 84 * 28.2 mm
ORIGIN	: Taiwan & China

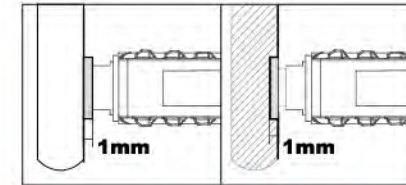

The washer could offer better contact while install the pedal into crank arm.



F178DU



BODY	: PC black
CAGE	: PC black or translucent color
SPINDLE	: Boron
BEARING	: Polymer bearing
SIZE	: 98 * 72.2 * 26 mm
ORIGIN	: Taiwan & China

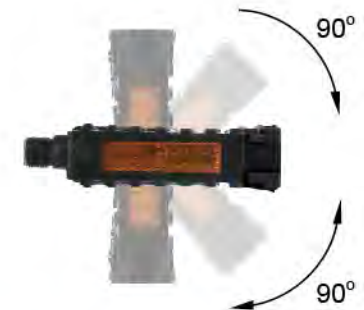
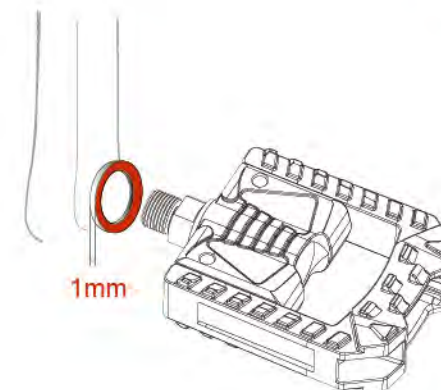

FOLDING

TOE CLIP

MT-3

Double supportive design with instep guard.
MT-3 size L,
MT-4 size S,
MT-5 size M.



MT-6

Large supportive design with instep guard.



MT-7

Mini toe-clip
Size: 82.7 x 53.8mm



RP-1

Classic road racing toe-clip
Size: M / L



MT-10

Strapless toe-clip for technical or casual riding.



MT-11

Large supportive design with instep guard and built-in reflector.
MT-11 size L,
MT-12 size M.



MT-14

Double supportive design with built-in reflector.
MT-13 size M,
MT-14 size L.



MT-19

Size: S / M / L / XL



NYLON TOE-STRAP

W-4

Nylon toe-strap with heavy-duty buckle.



Black

W-2



Black



White



Grey



Green



Blue



Red

SC-1

Foot guard to any strap attachable.



SPINDLE

K001

Axle replacement kit.

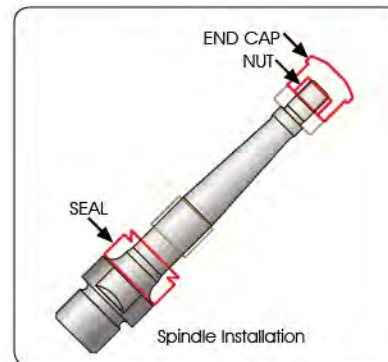

K004

Bearing replacement kit.

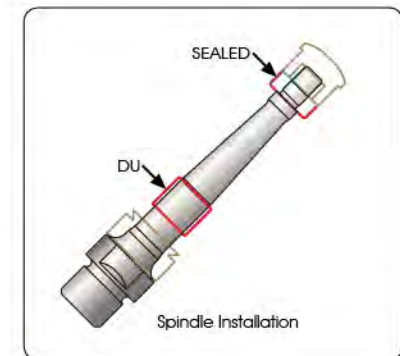

WRENCH



PIN OPTIONS

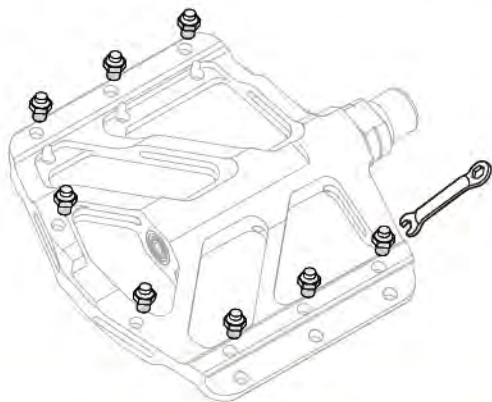

REFLECTOR

RR1-5



BOLT TYPE

Bolt-on reflector set for standard MTB pedals. 25 g/pr



SNAP ON

Snap-on reflector set.



LONG SNAP ON

Extra-long snap-on reflector set.



How to use 98A Reflector platform



98A-2 (60 g/pr)
Reflector for pedal
715 · 801 · 823 · M19 · M717 · M919 · MG8



98A-3 (60 g/pr)
Reflector for pedal
M094 · M18 · W01 · XMF3

1

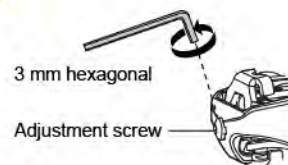

Use a 3mm hexagonal wrench to adjust the spring tension to the lowest tension.

3

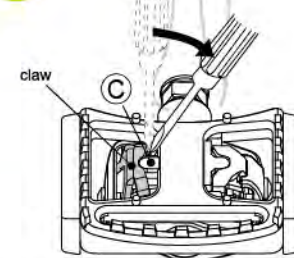

Use a straight (flat) screwdriver to push the back claw backwards for easier access to the reflector platform.

2

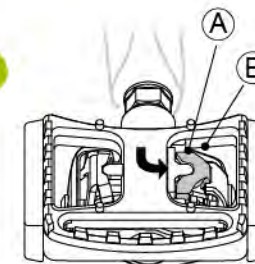

First, insert (A) point of the reflector platform into the front side of the pedal claw.

4

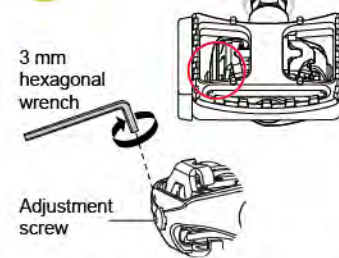

Once the reflector platforms are installed to the pedal, please adjust the spring tension to fit your need.

CLEAT



98R
Cleat kit
4 degree float
77 g/pr



98A
Cleat kit with improved
mud clearance features.
4 degree float
52 g/pr



RC8
New cleat design for mountain
clipless pedal to be assembled
on LOOK style shoes.
MATERIAL : Cr-Mo
126 g/pr



99A
Cleat kit
4 degree float
49 g/pr



RC-3
Cleat kit for WAM-R2 and R4.
4 degree float
105 g/pr

CLEAT PACKAGE





9°



RC-7A

Cleat kit for R096, R168 & E148
9 degree lateral float
82 g/pr



6°



RC-7B

Cleat kit for R096, R168 & E148
6 degree lateral float
82 g/pr



0°



RC-7C

Cleat kit for R096, R168 & E148
0 degree lateral float
82 g/pr

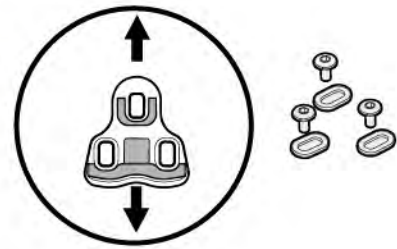

4 mm Allen Key



9°



RC-5

Cleat kit for WAM-R1, R3 and MG-9, W40, CR-1.
9 degree lateral float
90 g/pr



0°



RC-6

Cleat kit for WAM-R1, R3 and MG-9, W40, CR-1.
0 degree lateral float
90 g/pr

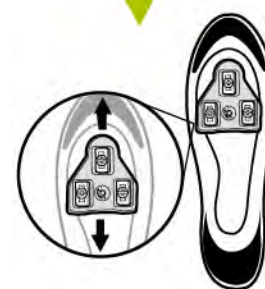
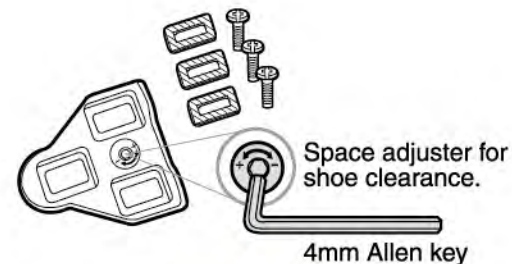



LU-934



BODY : Aluminum / Barrel silver
CAGE : Aluminum or Steel / ED black
SPINDLE : Boron
BEARING : Ball bearing
SIZE : 102 * 78 * 33.5 mm
ORIGIN : Taiwan & China



LU-964



BODY : Aluminum / Barrel silver
CAGE : Aluminum or Steel / ED black
SPINDLE : Boron
BEARING : Ball bearing
SIZE : 102 * 70 * 32 mm
ORIGIN : Taiwan & China



LU-946

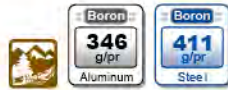

BODY : Aluminum / Barrel silver
CAGE : Aluminum or Steel / ED black
SPINDLE : Boron
BEARING : Ball bearing
SIZE : 100 * 78 * 32 mm
ORIGIN : Taiwan & China



LU-944



BODY : Aluminum / Barrel silver
CAGE : Aluminum or Steel / ED black
SPINDLE : Boron
BEARING : Ball bearing
SIZE : 100 * 74 * 30 mm
ORIGIN : Taiwan & China



LU-C015



BODY : Aluminum / Barrel silver
CAGE : Aluminum or Steel / ED black
SPINDLE : Boron
BEARING : Ball bearing
SIZE : 99 * 63 * 24 mm
ORIGIN : Taiwan & China



LU-C29G



BODY : Aluminum ED black
 with CNC machined
SPINDLE : Boron
BEARING : Ball bearing
SIZE : 101.8 * 66.8 * 28 mm
ORIGIN : Taiwan



LU-933



BODY : Plastic black
CAGE : Aluminum or Steel / ED black
SPINDLE : Boron
BEARING : Ball bearing
SIZE : 102 * 75 * 33 mm
ORIGIN : Taiwan & China



LU-C3



BODY : Plastic black
CAGE : Aluminum or Steel / ED black
SPINDLE : Boron
BEARING : Ball bearing
SIZE : 103 * 63 * 28 mm
ORIGIN : Taiwan & China



LU-C4



BODY : Plastic black
CAGE : Aluminum or Steel / ED black
SPINDLE : Boron
BEARING : Ball bearing
SIZE : 109.5 * 62 * 29 mm
ORIGIN : Taiwan & China



LU-C25



BODY : Plastic black
CAGE : Aluminum or Steel / ED black
SPINDLE : Boron
BEARING : Ball bearing
SIZE : 100 * 74 * 30 mm
ORIGIN : Taiwan & China



LU-948



BODY : Plastic black
CAGE : Aluminum or Steel / ED black
SPINDLE : Boron
BEARING : Ball bearing
SIZE : 98 * 74 * 30 mm
ORIGIN : Taiwan & China



LU-207

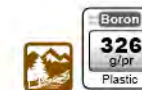

BODY : One piece plastic black
SPINDLE : Boron
BEARING : Ball bearing
SIZE : 105.9 * 80.8 * 29.5 mm
ORIGIN : Taiwan & China



LU-975



BODY : Aluminum
Barrel silver with kraton top

SPINDLE : Boron

BEARING : Ball bearing

SIZE : 103 * 71.5 * 31 mm

ORIGIN : Taiwan & China



LU-C33



BODY : Aluminum
Barrel silver with kraton top

SPINDLE : Boron

BEARING : Ball bearing

SIZE : 107 * 70 * 26.5 mm

ORIGIN : Taiwan & China



C157



BODY : Plastic with kraton top

SPINDLE : Boron

BEARING : Ball bearing

SIZE : 99 * 63.3 * 24.5 mm

ORIGIN : Taiwan & China



LU-206



BODY : Plastic with kraton top

SPINDLE : Boron

BEARING : Ball bearing

SIZE : 110 * 84 * 32 mm

ORIGIN : Taiwan & China



LU-T9



BODY : Plastic with kraton top

SPINDLE : Boron

BEARING : Ball bearing

SIZE : 103 * 69.5 * 28 mm

ORIGIN : Taiwan & China



LU-884



BODY : Plastic with kraton top

SPINDLE : Boron

BEARING : Ball bearing

SIZE : 105 * 72 * 32 mm

ORIGIN : Taiwan & China



LU-C35



BODY : Plastic with kraton top
SPINDLE : Boron
BEARING : Ball bearing
SIZE : 105 * 73.5 * 30 mm
ORIGIN : Taiwan & China



LU-941



BODY : Plastic with kraton top
SPINDLE : Boron
BEARING : Ball bearing
SIZE : 103 * 68 * 30 mm
ORIGIN : Taiwan & China



LU-C34



BODY : Plastic with kraton top
SPINDLE : Boron
BEARING : Ball bearing
SIZE : 108.5 * 72 * 28.5 mm
ORIGIN : Taiwan & China



P27



BODY : Plastic with kraton top
SPINDLE : Boron
BEARING : Ball bearing
SIZE : 102 * 83 * 29 mm
ORIGIN : Taiwan & China



LU-P6



BODY : Plastic with kraton top
SPINDLE : Boron
BEARING : Ball bearing
SIZE : 108 * 96 * 32 mm
ORIGIN : Taiwan & China



LU-990



BODY : Plastic with kraton top
SPINDLE : Boron
BEARING : Ball bearing
SIZE : 106.5 * 94 * 33.2 mm
ORIGIN : Taiwan & China



LU-P21



BODY : One piece plastic black
SPINDLE : Boron
BEARING : Ball bearing
SIZE : 90 * 65 * 31 mm
ORIGIN : Taiwan & China



LU-873



BODY : One piece plastic black
SPINDLE : Boron
BEARING : Ball bearing
SIZE : 90 * 65 * 29 mm
OPTION : Ball-less version as LU-873NB
ORIGIN : Taiwan & China



LU-937NB



BODY : One piece plastic black
SPINDLE : Steel
BEARING : Ball-less
SIZE : 95 * 64 * 27 mm
ORIGIN : Taiwan & China



LU-942NB



BODY : One piece plastic black
SPINDLE : Steel
BEARING : Ball-less
SIZE : 90.5 * 61.5 * 26 mm
ORIGIN : Taiwan & China



LU-213NB



BODY : One piece plastic black
SPINDLE : Steel
BEARING : Ball-less
SIZE : 99 * 74 * 30 mm
ORIGIN : Taiwan & China



LU-894



BODY : One piece plastic black
SPINDLE : Boron
BEARING : Ball bearing
SIZE : 108.5 * 68.5 * 26 mm
ORIGIN : Taiwan & China



LU-892DU



BODY : One piece plastic black
SPINDLE : Boron
BEARING : Polymer bearing
SIZE : 99 * 75 * 31 mm
OPTION : Ball bearing version as LU-892
ORIGIN : Taiwan & China



LU-P26



BODY : One piece plastic black
SPINDLE : Boron
BEARING : Ball bearing
SIZE : 111 * 83 * 28 mm
ORIGIN : Taiwan & China



LU-866



BODY : One piece plastic black
SPINDLE : Boron
BEARING : Ball bearing
SIZE : 106 * 71.5 * 36.5 mm
ORIGIN : Taiwan & China



R-11



BODY : Plastic black
CAGE : Aluminum / ED black
SPINDLE : Boron
BEARING : Ball bearing
SIZE : 99 * 63 * 29 mm
ORIGIN : Taiwan & China



R173



BODY : Plastic black
CAGE : Aluminum or Steel / ED black
SPINDLE : Cr-Mo
BEARING : Ball bearing
SIZE : 103.5 * 63 * 23.5 mm
ORIGIN : Taiwan & China



LU-209



BODY : Aluminum / Barrel silver
SPINDLE : Boron
BEARING : Ball bearing
SIZE : 87.2 * 86.4 * 29.8 mm
ORIGIN : Taiwan & China



LU-204



BODY : Aluminum
ED black or painted

SPINDLE : Boron

BEARING : Ball bearing

SIZE : 94.2 * 84.2 * 29.8 mm

ORIGIN : Taiwan & China



LU-P17



BODY : One piece plastic black

SPINDLE : Boron

BEARING : Ball bearing

SIZE : 92 * 85.5 * 29.5 mm

ORIGIN : Taiwan & China



LU-968



BODY : One piece plastic black

SPINDLE : Boron

BEARING : Ball bearing

SIZE : 95.5 * 81.5 * 29.5 mm

ORIGIN : Taiwan & China



LU-313



BODY : Aluminum
ED black or painted

SPINDLE : Boron

BEARING : Ball bearing

SIZE : 109.5 * 105 * 30 mm

ORIGIN : Taiwan & China



LU-A18



BODY : Aluminum
ED black or painted

SPINDLE : Boron

BEARING : Ball bearing

SIZE : 106 * 104 * 31 mm

ORIGIN : Taiwan & China



LU-B78

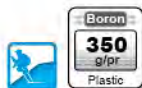

BODY : One piece plastic black
SPINDLE : Boron
BEARING : Ball bearing
SIZE : 100.5 * 95.5 * 32 mm
ORIGIN : Taiwan & China



LU-984



BODY : One piece plastic black
SPINDLE : Boron
BEARING : Ball bearing
SIZE : 107 * 95.5 * 28 mm
OPTION : 2DU version as LU-984DU
ORIGIN : Taiwan & China



LU-205



BODY : One piece plastic black
SPINDLE : Boron
BEARING : Ball bearing
SIZE : 111.5 * 99 * 31.5 mm
ORIGIN : Taiwan & China



LU-P9



BODY : One piece plastic black
SPINDLE : Boron
BEARING : Ball bearing
SIZE : 108 * 105 * 32.5 mm
ORIGIN : Taiwan & China

WELLGO PEDAL'S CORP.

NO.3, Gong 7th Road, Youth Ind.Park,
Dajia Dist., Taichung City 437,
Taiwan
TEL: 886-4-26816991-5
FAX: 886-4-2681-6988, 2681-6998
HTTP://www.wellgopedal.com
E-MAIL: wd@wellgopedal.com

WELLMAG TECHNOLOGY CO., LTD.

NO.137, Qingnian Rd., Youth Ind.Park,
Dajia Dist., Taichung City 437,
Taiwan
TEL: 886-4-2682-2398-9
FAX: 886-4-2682-1909
HTTP://www.wellmag.com.tw
E-MAIL: wellmag1@wellmag.com.tw

SHANGHAI FACTORY

NO.103, Yuehd-Ho South Road
Economic & Technical Development Zone,
Kunshan, Jiangsu, China
TEL: 86-512-57701991-4
FAX: 86-512-57701995
HTTP://www.wellgopedal.cn
E-MAIL: wellgo@wellgopedal.cn



www.wellgopedal.com