

wellgo

2017

www.wellgopedal.com



CLEAT
APPLICATION
TABLE



	M279	M250	M177B	M094B	W-01	WAM M19	WAM M919	M221B	WPD 823	WPD 801	HR292	R292	R251	R168	R096B	MG-9	W-40	R226	R191B	W-44	W-43	B213	W-70	WAM D10	C176B	C002B	WPD M17C	WPD 95B	E229B	WPD E003	WPD E14		
98A	4°	4°	4°	4°	4°	4°	4°	4°	4°	4°								4°	4°	4°	4°	4°	4°	4°	4°	4°	4°	4°	4°	4°	4°		
RC8	4°	4°	4°	4°	4°	4°	4°	4°	4°	4°								4°	4°	4°	4°	4°	4°	4°	4°	4°	4°	4°	4°	4°	4°		
98R																			4°	4°													
RC5																																	
RC6																																	
RC7-A																																	
RC7-B																																	
RC7-C																																	

USED TO

THIN & LIGHT



LU-884

33mm



C098

23.7mm



LU-954

30.3mm



M-21

24mm



LU-A8

34.4mm



MG6-AL

20.8mm





2009 TBEA Creative Bicycles, Parts and Accessories Competition Award.

Quick Release Device













WELLGO QRD is available for many of our new and existing pedals in every category.











No tools are required and pedals can be removed with a flick of a finger.

The QRD design offers portability and additional security for bicycles when they are parked.

The ability to quickly remove the pedals without any tools save time when storing your bike in limited spaces (e.g. car, closet, box).

SYMBOL

-  MTB  ROAD  PLATFORM
-  CITY  TREKKING  FOLDING
-  EXERCISER  YOUTH  CLASSIC
-  ACCESSORIES
-  R.B.
-  2DU
-  Multi function
-  Quick Release Device
-  Quick Release Device II
-  Magnesium & Aluminum Body
-  Grease hole design for easy maintenance.

 SELECTION	10
 MTB	16
 ROAD	21
 PLATFORM	26
 CITY / TREKKING	32
 FOLDING	37
 EXERCISER	38
 YOUTH	40
 CLASSIC	42
 ACCESSORIES	45

HR292

WEIGHT : 293g
BODY : 6061 CNC Aluminum
FINISH : Anodized
SPINDLE : Cr-Mo
BEARING : 3 Sealed
CLEAT : RC7A/B/C compatible
SIZE : 84.5 x 90.2 x 30.2 mm
ORIGIN : Taiwan



Cadence Pedal

NEW

A tool which helps determine when is the best time to shift gears while riding would help to ride more efficiency. Integrated into the pedal would eliminate extra parts on the bikes.

- 2.4g ANT+ / BLE 4.0 compatible
- 150 hrs with CR1632 button battery



NEW R.B.

Polymer bearing + Sealed

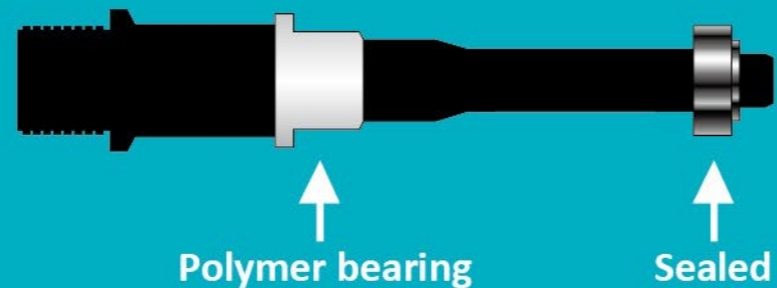

Affordable Pricing

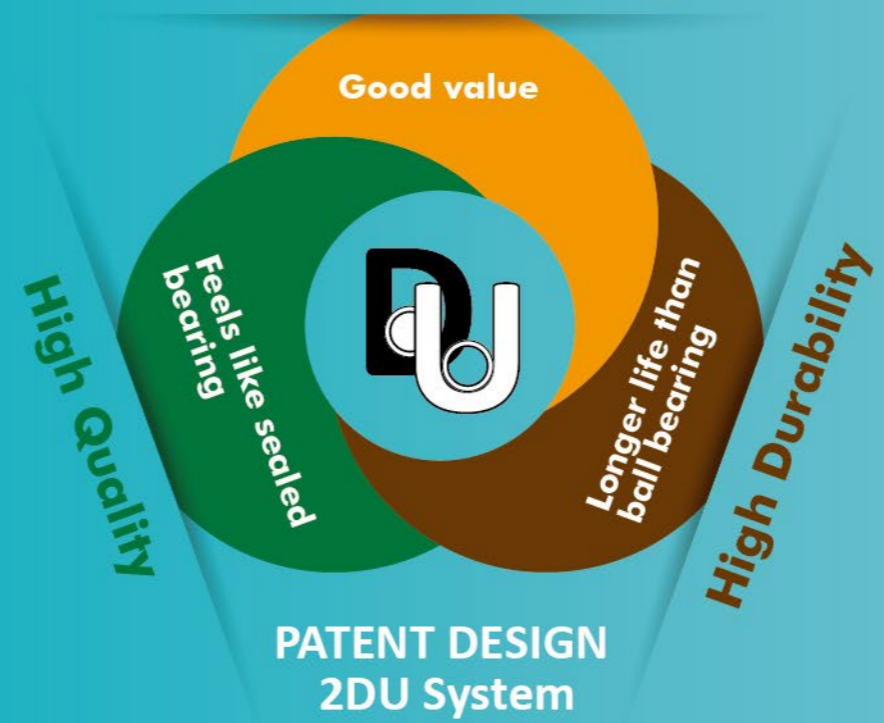

M248DU



R198



C280DU



C172DU



B249DU

PATENT DESIGN
NEW R.B System

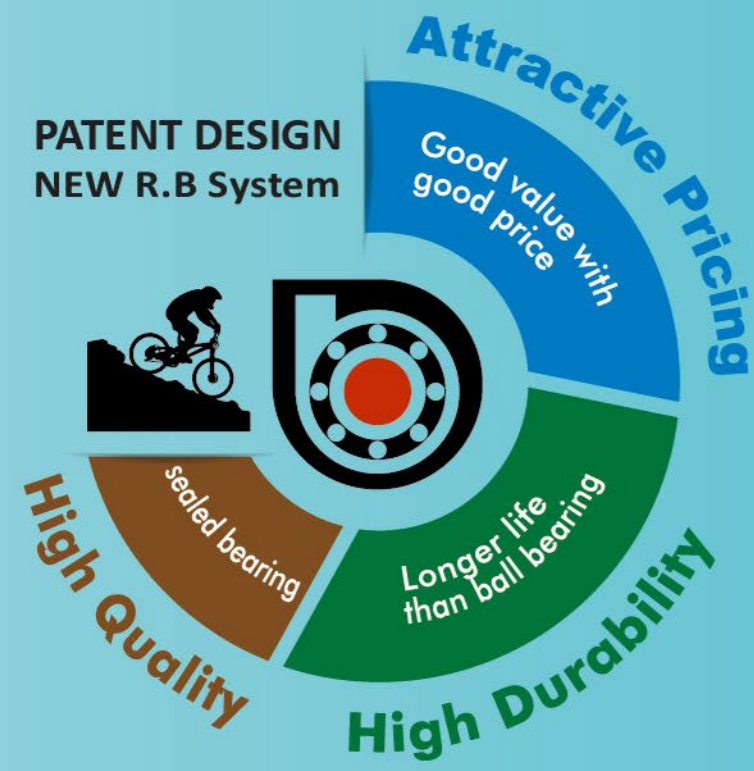

NEW



M255



M298



M259



C235



B230

2DU

Polymer bearing X 2

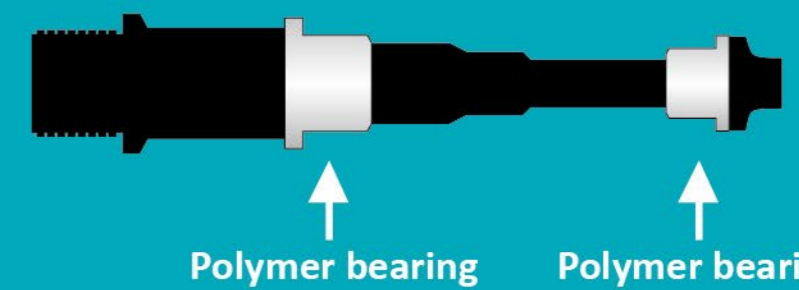

M111

WEIGHT : 228g
BODY : 6061 Forged Aluminum
FINISH : Anodized
SPINDLE : Cr-Mo
BEARING : DU / Sealed
SIZE : 99 x 61 x 18 mm
ORIGIN : Taiwan

**M20**

WEIGHT : 248g (Al)
 303g (Steel)
BODY : Aluminum
FINISH : Barrel silver
CAGE : Aluminum or Steel
SPINDLE : Cr-Mo
BEARING : DU / Sealed
SIZE : 101.1 x 63 x 24 mm
ORIGIN : Taiwan

**M232**

WEIGHT : 192g (Mg)
 232g (Al)
BODY : Aluminum / Magnesium
FINISH : ED black or painted
SPINDLE : Cr-Mo
BEARING : DU / Sealed
SIZE : 98 x 65 x 20 mm
ORIGIN : Taiwan

**M255RB**

WEIGHT : 272g
BODY : Aluminum
FINISH : Barrel silver
CAGE : Aluminum
SPINDLE : Boron
BEARING : DU / Sealed
SIZE : 102.4 x 63.2 x 24 mm
OPTION : M255 as Ball bearing version
ORIGIN : Taiwan



NEW

M298RB

WEIGHT : 282g
BODY : Aluminum
FINISH : Barrel silver
CAGE : Aluminum
SPINDLE : Boron
BEARING : DU / Sealed
SIZE : 101.7 x 63.4 x 24.3 mm
OPTION : M298 as Ball bearing version
ORIGIN : Taiwan



NEW

M259RB

WEIGHT : 328g
BODY : Aluminum
FINISH : Barrel silver
SPINDLE : Boron
BEARING : DU / Sealed
SIZE : 109.1 x 74 x 25 mm
OPTION : M259 as Ball bearing version
ORIGIN : Taiwan



NEW

M248DU

WEIGHT : 254g (Al)
 312g (Steel)
BODY : Aluminum
FINISH : Barrel silver
CAGE : Aluminum or Steel
SPINDLE : Boron
BEARING : Polymer bearing
SIZE : 99.7 x 63.2 x 23.5 mm
ORIGIN : Taiwan & China

**M195DU**

WEIGHT : 332g
BODY : Aluminum
FINISH : Barrel silver
SPINDLE : Boron
BEARING : Polymer bearing
SIZE : 100 x 100 x 26.5 mm
OPTION : M195 as Ball bearing version
 M195B as Sealed bearing version
ORIGIN : Taiwan & China

**M141DU**

WEIGHT : 246g (Al)
 301g (Steel)
BODY : Plastic black
CAGE : Aluminum or Steel
SPINDLE : Boron
BEARING : Polymer bearing
SIZE : 105.3 x 63 x 24 mm
OPTION : M141 as Ball bearing version
ORIGIN : Taiwan & China



Snap in toe clip system.

LU-895DU

WEIGHT : 223g
BODY : One piece plastic black
SPINDLE : Boron
BEARING : Polymer bearing
SIZE : 105.5 x 86 x 23 mm
ORIGIN : Taiwan & China





R110B

WEIGHT : 240g
BODY : Aluminum
FINISH : Barrel silver
CAGE : Aluminum
SPINDLE : Cr-Mo
BEARING : DU / Sealed
SIZE : 88 x 68.6 x 29 mm
OPTION : R110 as Ball bearing version
ORIGIN : Taiwan



R200B

WEIGHT : 242g (Al)
 296g (Steel)
BODY : Aluminum
FINISH : Barrel silver
CAGE : Aluminum or Steel
SPINDLE : Cr-Mo
BEARING : DU / Sealed
SIZE : 99 x 63.2 x 22 mm
OPTION : R200 as Ball bearing version
 R200DU as 2DU version
ORIGIN : Taiwan & China



B102B

WEIGHT : 410g
BODY : Aluminum
FINISH : ED black or painted
SPINDLE : Cr-Mo
BEARING : DU / Sealed
SIZE : 113.5 x 102 x 27.6 mm
OPTION : B102 as Ball bearing with mold pin
ORIGIN : Taiwan



B223BN

WEIGHT : 340g
BODY : Nylon with Fiber
SPINDLE : Cr-Mo
BEARING : DU / Sealed
SIZE : 111 x 100 x 27 mm
OPTION : B223N as Ball bearing version
ORIGIN : Taiwan



R296RB

WEIGHT : 274g
BODY : Aluminum
FINISH : Barrel silver
CAGE : Aluminum
SPINDLE : Boron
BEARING : DU / Sealed
SIZE : 109.6 x 63.4 x 24.3 mm
OPTION : R296 as Ball bearing version
ORIGIN : Taiwan



B230RB

WEIGHT : 442g
BODY : Aluminum with mold pin
FINISH : ED black
SPINDLE : Boron
BEARING : DU / Sealed
SIZE : 112.4 x 105 x 29.4 mm
OPTION : B230 as Ball bearing version
ORIGIN : Taiwan



R126DU

WEIGHT : 274g (Al)
 330g (Steel)
BODY : Aluminum
FINISH : Barrel silver
CAGE : Aluminum or Steel
SPINDLE : Boron
BEARING : Polymer bearing
SIZE : 104.6 x 63 x 24 mm
OPTION : R126B as Sealed bearing version
 R126 as Ball bearing version
ORIGIN : Taiwan & China



R198

WEIGHT : 304g
BODY : Plastic black
SPINDLE : Boron
BEARING : Polymer bearing
SIZE : 90.9 x 96.9 x 22.5 mm
ORIGIN : Taiwan



B249DU

WEIGHT : 390g
BODY : Aluminum
FINISH : Barrel silver or ED black
SPINDLE : Boron
BEARING : Polymer bearing
SIZE : 111.5 x 102 x 27.6 mm
ORIGIN : Taiwan & China



B239DU

WEIGHT : 276g
BODY : Plastic
SPINDLE : Boron
BEARING : Polymer bearing
SIZE : 115.4 x 100 x 26 mm
OPTION : B239 as Ball bearing version
ORIGIN : Taiwan & China





C089B

WEIGHT : 232g
BODY : Aluminum
FINISH : Barrel silver
CAGE : Aluminum
SPINDLE : Cr-Mo
BEARING : DU / Sealed
SIZE : 86.7 x 63.2 x 20 mm
OPTION : C089 as Ball bearing version
ORIGIN : Taiwan



C098B

WEIGHT : 288g
BODY : Aluminum
CAGE : Plastic cage overmolded kraton
SPINDLE : Cr-Mo
BEARING : DU / Sealed
SIZE : 103 x 79.5 x 24 mm
OPTION : C098 as Ball bearing version
ORIGIN : Taiwan



C220B

WEIGHT : 362g
BODY : Aluminum with kraton top
FINISH : Barrel silver
SPINDLE : Cr-Mo
BEARING : DU / Sealed
SIZE : 108 x 82 x 28 mm
OPTION : C220 as Ball bearing version
 C220DU as 2DU version
ORIGIN : Taiwan & China



C210B

WEIGHT : 327g
BODY : Aluminum
FINISH : Barrel silver
SPINDLE : Cr-Mo
BEARING : DU / Sealed
SIZE : 102 x 75 x 25 mm
OPTION : C210 as Ball bearing version
ORIGIN : Taiwan & China



C235RB

WEIGHT : 348g
BODY : Aluminum with kraton top
FINISH : Barrel silver
SPINDLE : Boron
BEARING : DU / Sealed
SIZE : 107.8 x 81.8 x 25.8 mm
OPTION : C235 as Ball bearing version
ORIGIN : Taiwan



C297RB

WEIGHT : 282g
BODY : Aluminum
FINISH : Barrel silver
CAGE : Aluminum
SPINDLE : Boron
BEARING : DU / Sealed
SIZE : 101.1 x 63.4 x 24.3 mm
OPTION : C297 as Ball bearing version
ORIGIN : Taiwan



C280DU

WEIGHT : 327g
BODY : Aluminum
FINISH : Barrel silver
SPINDLE : Boron
BEARING : Polymer bearing
SIZE : 104.9 x 77.6 x 24 mm
ORIGIN : Taiwan & China



C169DU

WEIGHT : 366g
BODY : Aluminum with kraton top
FINISH : Barrel silver
SPINDLE : Boron
BEARING : Polymer bearing
SIZE : 105 x 80 x 27 mm
OPTION : C169B as Sealed bearing version
 C169 as Ball bearing version
ORIGIN : Taiwan & China



C211

WEIGHT : 332g
BODY : Plastic W/Sand Paper
SPINDLE : Boron
BEARING : Polymer bearing
SIZE : 109.1 x 89.5 x 27.2 mm
ORIGIN : Taiwan



C172DU

WEIGHT : 245g
BODY : Plastic with kraton top
SPINDLE : Boron
BEARING : Polymer bearing
SIZE : 106.5 x 81 x 24.8 mm
OPTION : C172 as Ball bearing version
ORIGIN : Taiwan & China





M279

WEIGHT : 350g
BODY : Aluminum
FINISH : ED black or painted
SPINDLE : Cr-Mo
BEARING : Polymer bearing
CLEAT : 98A
SIZE : 80 x 82 x 38 mm
ORIGIN : Taiwan



FEATURES:

1. Unique one piece claw design offers better clip release function.
2. Tension indicator with anti-loose design prevents losing screws accidentally.
3. 2DU Cartridge sleeve design offer easy replaceable ability.



M250

WEIGHT : 324g
BODY : Aluminum
FINISH : ED black or painted
SPINDLE : Cr-Mo
BEARING : DU / Sealed
CLEAT : 98A
SIZE : 80 x 61 x 33.5 mm
ORIGIN : Taiwan



FEATURES:

1. Stainless plate prevents scratches from clipping in & out.
2. Stronger spring tension offers better connection between pedals and shoes which could increase the riding efficiency.
3. Tension indicator with anti-loose design prevents losing screws accidentally.

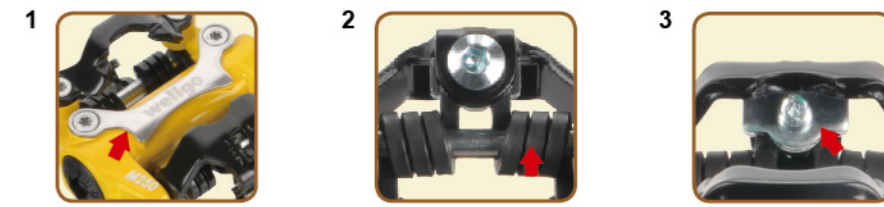

M177B

WEIGHT : 260g (Ti/Mg)
 300g (Cr-Mo/Mg)
 334g (Cr-Mo/Al)
BODY : Aluminum / Magnesium
FINISH : ED black or painted
SPINDLE : Cr-Mo or Ti
BEARING : DU / Sealed
CLEAT : 98A
SIZE : 84 x 64.5 x 34 mm
OPTION : M177 as Ball bearing version
ORIGIN : Taiwan



M094B

WEIGHT : 300g (Mg)
 318g (Al)
BODY : Aluminum / Magnesium
FINISH : ED black or painted
SPINDLE : Cr-Mo
BEARING : DU / Sealed
CLEAT : 98A
SIZE : 80.9 x 65.3 x 33.8 mm
OPTION : M094 as Ball bearing version
ORIGIN : Taiwan



W-01

WEIGHT : 237g (Ti/Mg)
 300g (Cr-Mo/Al)
BODY : Aluminum / Magnesium
FINISH : ED black or painted
SPINDLE : Cr-Mo or Ti
BEARING : DU / Sealed
CLEAT : 98A
SIZE : 80.1 x 66 x 30.6 mm
ORIGIN : Taiwan



WAM-M19

WEIGHT : 252g (Ti/Mg)
 300g (Cr-Mo/Al)
BODY : Aluminum / Magnesium
FINISH : ED black or painted
SPINDLE : Cr-Mo or Ti
BEARING : DU / Sealed
CLEAT : 98A
SIZE : 79.8 x 59.8 x 30.1 mm
ORIGIN : Taiwan

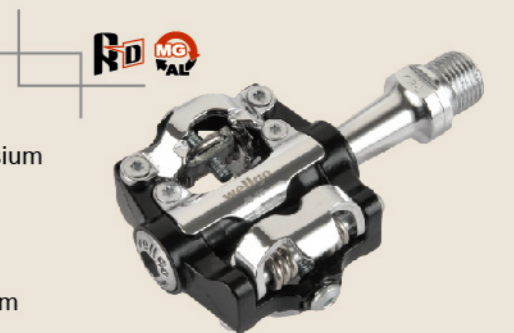

WAM-M919

WEIGHT : 340g
BODY : Aluminum
FINISH : ED black or painted
SPINDLE : Cr-Mo
BEARING : Ball bearing
CLEAT : 98A
SIZE : 83.8 x 58.9 x 35.5 mm
ORIGIN : Taiwan



M221B

WEIGHT : 418g
BODY : Aluminum
FINISH : ED black or painted
SPINDLE : Cr-Mo
BEARING : DU / Sealed
CLEAT : 98A
SIZE : 88.7 x 91 x 34 mm
OPTION : M221 as Ball bearing version
ORIGIN : Taiwan



WPD-823

WEIGHT : 360g
BODY : Aluminum
FINISH : ED black or painted
SPINDLE : Cr-Mo
BEARING : Ball bearing
CLEAT : 98A
SIZE : 81.4 x 63 x 34.5 mm
ORIGIN : Taiwan



WPD-801

WEIGHT : 298g (Ti/Mg)
 358g (Cr-Mo/Al)
BODY : Aluminum / Magnesium
FINISH : ED black or painted
SPINDLE : Cr-Mo or Ti
BEARING : DU / Sealed
CLEAT : 98A
SIZE : 82.4 x 66.8 x 32.8 mm
OPTION : MG-18 as Magnesium version
ORIGIN : Taiwan



M256

WEIGHT : 270g
BODY : 6061 CNC Aluminum
FINISH : Anodized
SPINDLE : Cr-Mo
BEARING : DU / Sealed
SIZE : 105 x 70 x 20 mm
ORIGIN : Taiwan



M194

WEIGHT : 243g
BODY : 6061 CNC Aluminum
FINISH : Anodized
SPINDLE : Cr-Mo
BEARING : DU / Sealed
SIZE : 100 x 99.3 x 23 mm
ORIGIN : Taiwan



M151

WEIGHT : 270g
BODY : 6061 CNC Aluminum
FINISH : Anodized
CAGE : Aluminum
SPINDLE : Cr-Mo
BEARING : DU / Sealed
SIZE : 107 x 60 x 22 mm
ORIGIN : Taiwan



Multi Function Pedal

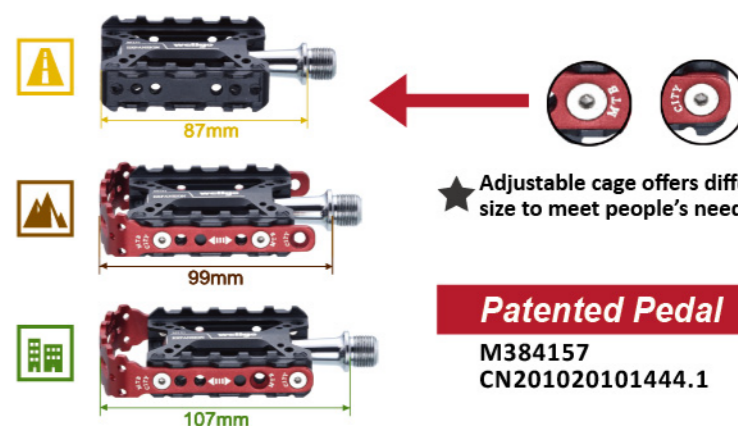

M142

WEIGHT : 236g
BODY : 6061 CNC Aluminum
FINISH : Anodized
SPINDLE : Cr-Mo
BEARING : DU / Sealed
SIZE : 100 x 60 x 24.5 mm
ORIGIN : Taiwan



M079

WEIGHT : 238g
BODY : 6061 CNC Aluminum
FINISH : Anodized
SPINDLE : Cr-Mo
BEARING : DU / Sealed
SIZE : 100.8 x 60 x 24.4 mm
ORIGIN : Taiwan



M138

WEIGHT : 238g (Mg)
 288g (Al)
BODY : Aluminum / Magnesium
FINISH : ED black or painted
SPINDLE : Cr-Mo
BEARING : DU / Sealed
SIZE : 102 x 68 x 29 mm
ORIGIN : Taiwan



M224G

WEIGHT : 315g
BODY : Aluminum
FINISH : ED black with CNC machined
SPINDLE : Boron
BEARING : Ball bearing
SIZE : 102.5 x 66 x 25 mm
OPTION : M224GB as Sealed bearing version
 M224GDU as 2DU version
ORIGIN : Taiwan & China



LU-C27G

WEIGHT : 270g
BODY : Aluminum
FINISH : ED black with CNC machined
SPINDLE : Cr-Mo
BEARING : Ball bearing
SIZE : 101.5 x 63.3 x 23.3 mm
OPTION : LU-C27GB as Sealed bearing
 LU-C27 as Cage without machined
ORIGIN : Taiwan



M21

WEIGHT : 238g (Al)
 293g (Steel)
BODY : Aluminum
FINISH : Barrel silver
CAGE : Aluminum or Steel
SPINDLE : Cr-Mo
BEARING : Ball bearing
SIZE : 100.7 x 63 x 24 mm
ORIGIN : Taiwan



M272DU

WEIGHT : 240g
BODY : Aluminum
FINISH : Barrel silver
CAGE : Aluminum
SPINDLE : Boron
BEARING : Polymer bearing
SIZE : 101 x 62.6 x 24 mm
ORIGIN : Taiwan & China



M149

WEIGHT : 248g (Al)
 308g (Steel)
BODY : Aluminum
FINISH : Barrel silver
CAGE : Aluminum or Steel
SPINDLE : Cr-Mo
BEARING : Ball bearing
SIZE : 97 x 63 x 24 mm
OPTION : M149B as Sealed bearing version
 M149DU as 2DU version
ORIGIN : Taiwan & China



M270DU

WEIGHT : 232g (Al)
286g (Steel)
BODY : Plastic black
CAGE : Aluminum or Steel
SPINDLE : Boron
BEARING : Polymer bearing
SIZE : 100 x 63.2 x 24 mm
ORIGIN : Taiwan



M085DU

WEIGHT : 240g (Al)
296g (Steel)
BODY : Plastic black
CAGE : Aluminum or Steel
SPINDLE : Boron
BEARING : Polymer bearing
SIZE : 99 x 63 x 24 mm
OPTION : M085 as Ball bearing version
ORIGIN : Taiwan & China



R251

WEIGHT : 282g
BODY : Aluminum
FINISH : ED black or painted
SPINDLE : Cr-Mo
BEARING : Polymer bearing
CLEAT : RC7A/ B/ C compatible
SIZE : 87 x 89 x 32 mm
ORIGIN : Taiwan



FEATURES:

1. Dynamic Streamline body design.
2. Wider stepping surface offers more comfortable riding. With the stainless plate composition could prevent the body from scratch while clip in and out.
3. Stronger spring tension design makes shoes and cleats connect tighter which will improve riding efficiency.
4. Cartridge sleeve design with Wellgo New 2 DU patent system offer easy replaceable ability.



M273DU

WEIGHT : 216g
BODY : Plastic black
CAGE : Aluminum
SPINDLE : Boron
BEARING : Polymer bearing
SIZE : 101 x 62.6 x 24 mm
ORIGIN : Taiwan & China



M253DU

WEIGHT : 242g (Al)
283g (Steel)
BODY : Plastic black
CAGE : Aluminum or Steel
SPINDLE : Boron
BEARING : Polymer bearing
SIZE : 103 x 76.3 x 34.3 mm
ORIGIN : Taiwan & China



R168

WEIGHT : 205g (Ti)
250g (Cr-Mo)
BODY : Engineering plastic
SPINDLE : Cr-Mo or Ti
BEARING : 3 Sealed bearing
CLEAT : RC7A/ B/ C compatible
SIZE : 89.8 x 81 x 32.5 mm
ORIGIN : Taiwan



POSI-R168 WELLGO INNOVATION Auto Reset Positioner

By using the magnet element, the ARP helps to control the clipless step entry side to riders wish.

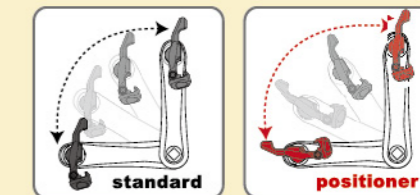

By using ARP, riders could easily clip the shoes into the pedal without looking at the pedal to reduce possible injury for missing the engagement.



M095

WEIGHT : 202g
BODY : One piece plastic black
SPINDLE : Cr-Mo
BEARING : Ball bearing
SIZE : 103 x 76 x 25.5 mm
ORIGIN : Taiwan & China



M113

WEIGHT : 206g
BODY : One piece plastic black
SPINDLE : Boron
BEARING : Ball bearing
SIZE : 103.5 x 78 x 25.5 mm
ORIGIN : Taiwan & China



R292

WEIGHT : 270g
BODY : 6061 CNC Aluminum
FINISH : Anodized
SPINDLE : Cr-Mo
BEARING : 3 Sealed
CLEAT : RC7A/B/C compatible
SIZE : 84.5 x 90.2 x 30.2 mm
ORIGIN : Taiwan



R096B

WEIGHT : 242g (Ti/Mg)
292g (Cr-Mo/Mg)
326g (Cr-Mo/Al)
BODY : Aluminum / Magnesium
FINISH : ED black or painted
SPINDLE : Cr-Mo or Ti
BEARING : Needle / Sealed
CLEAT : RC7A/ B/ C compatible
SIZE : 81 x 87 x 33 mm
OPTION : R096 as Ball bearing version
ORIGIN : Taiwan



MG-9

WEIGHT : 262g (Ti)
312g (Cr-Mo)
BODY : Magnesium
FINISH : Painted
SPINDLE : Cr-Mo or Ti
BEARING : DU / Sealed
CLEAT : RC-5 / RC-6,
LOOK "ARC" compatible
SIZE : 85.2 x 95.8 x 34.2 mm
ORIGIN : Taiwan



W40B

WEIGHT : 266g (Mg)
328g (Al)
BODY : Aluminum
FINISH : ED black or painted
SPINDLE : Cr-Mo
BEARING : DU / Sealed
CLEAT : RC-5 / RC-6
LOOK "ARC" compatible
SIZE : 85 x 92 x 33 mm
OPTION : W40 as Ball bearing version
ORIGIN : Taiwan



R226

WEIGHT : 295g
BODY : Aluminum
FINISH : Barrel silver or painted
SPINDLE : Cr-Mo
BEARING : DU / Sealed
CLEAT : 98A
SIZE : 81.5 x 84.5 x 29.5 mm
ORIGIN : Taiwan



R191B

WEIGHT : 340g (Ti)
380g (Cr-Mo)
BODY : Aluminum with kraton top
FINISH : Barrel silver
SPINDLE : Cr-Mo or Ti
BEARING : DU / Sealed
CLEAT : 98A
SIZE : 90 x 87.5 x 32 mm
OPTION : R191 as Ball bearing version
ORIGIN : Taiwan



W-44B

WEIGHT : 358g
BODY : Aluminum
FINISH : ED black or painted
SPINDLE : Cr-Mo
BEARING : DU / Sealed
CLEAT : 98A
SIZE : 82.8 x 76 x 46.8 mm
OPTION : W44 as Ball bearing version
ORIGIN : Taiwan

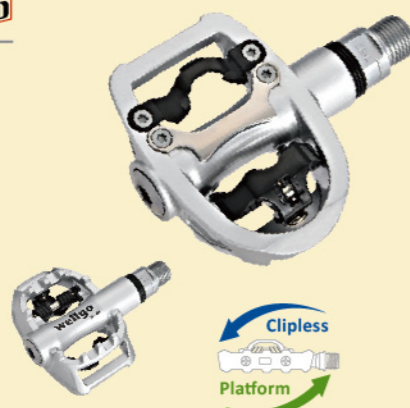

W-43

WEIGHT : 396g
BODY : Aluminum
FINISH : Barrel silver or painted
SPINDLE : Cr-Mo
BEARING : Ball bearing
CLEAT : 98A
SIZE : 90 x 100 x 32.5 mm
ORIGIN : Taiwan

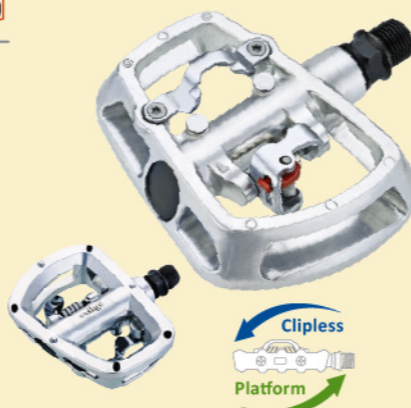

R277

WEIGHT : 228g
BODY : 6061 CNC Aluminum
FINISH : Anodized
SPINDLE : Cr-Mo
BEARING : DU / Sealed
SIZE : 87 x 98.5 x 22.5 mm
ORIGIN : Taiwan



R282

WEIGHT : 224g
BODY : 6061 CNC Aluminum
FINISH : Anodized
SPINDLE : Cr-Mo
BEARING : DU / Sealed
SIZE : 95 x 60 x 21.6 mm
ORIGIN : Taiwan



R074

WEIGHT : 228g
BODY : 6061 CNC Aluminum
FINISH : Anodized
SPINDLE : Cr-Mo
BEARING : DU / Sealed
SIZE : 91.5 x 60 x 21.6 mm
ORIGIN : Taiwan



LU-C16

WEIGHT : 230g (Ti)
280g (Cr-Mo)
BODY : 6061 CNC Aluminum
FINISH : Anodized
SPINDLE : Cr-Mo or Ti
BEARING : DU / Sealed
SIZE : 92.9 x 61.5 x 22 mm
ORIGIN : Taiwan



R146

WEIGHT : 310g
BODY : Aluminum
FINISH : ED black or painted
SPINDLE : Cr-Mo
BEARING : DU / Sealed
SIZE : 85 x 86 x 32 mm
ORIGIN : Taiwan



R183

WEIGHT : 272g
BODY : Aluminum
FINISH : Barrel silver or ED black
SPINDLE : Cr-Mo
BEARING : Ball bearing
SIZE : 107 x 63.5 x 30 mm
OPTION : R183B as Sealed bearing version
ORIGIN : Taiwan



R125

WEIGHT : 217g (Al)
 272g (Steel)
BODY : Plastic black
CAGE : Aluminum or Steel
SPINDLE : Cr-Mo
BEARING : Ball bearing
SIZE : 104.6 x 63.2 x 24 mm
OPTION : R125DU as 2DU version
ORIGIN : Taiwan & China



R199

WEIGHT : 215g
BODY : Plastic black
CAGE : Aluminum or Steel
SPINDLE : Cr-Mo
BEARING : Ball bearing
SIZE : 99 x 63.2 x 22 mm
OPTION : R199DU as 2DU version
ORIGIN : Taiwan & China



R262DU

WEIGHT : 232g (Al)
 286g (Steel)
BODY : Plastic black
CAGE : Aluminum or Steel
SPINDLE : Boron
BEARING : Polymer bearing
SIZE : 100.1x 63.2 x 22 mm
ORIGIN : Taiwan & China



R261DU

WEIGHT : 240g (Al)
 296g (Steel)
BODY : Plastic black
CAGE : Aluminum or Steel
SPINDLE : Boron
BEARING : Polymer bearing
SIZE : 104.2 x 63.2 x 23.8 mm
ORIGIN : Taiwan & China



R090

WEIGHT : 206g
BODY : One piece plastic black
SPINDLE : Cr-Mo
BEARING : Ball bearing
SIZE : 99 x 79.8 x 24 mm
ORIGIN : Taiwan



R025B

WEIGHT : 238g
BODY : Aluminum
FINISH : Barrel silver
CAGE : Aluminum
SPINDLE : Cr-Mo
BEARING : DU / Sealed
SIZE : 90.1 x 64.8 x 27.7 mm
OPTION : R025 as Ball bearing version
ORIGIN : Taiwan



R104B

WEIGHT : 254g
BODY : Aluminum
FINISH : Barrel silver
CAGE : Aluminum
SPINDLE : Cr-Mo
BEARING : DU / Sealed
SIZE : 104 x 65.6 x 30.8 mm
OPTION : R104 as Ball bearing version
ORIGIN : Taiwan



MT-16

Steel toe-clip with CP finished.
 Size: M / L / XL



MT-20

Steel toe-clip with CP finished.
 Size: M / L



MT-21

Steel toe-clip with CP finished.
 Size: M / L



OTHER OPTIONS



Brown

Black

W-5

Single leather strap



White

Brown

Black

W-6

Double leather strap



White

Brown

Black

B213

WEIGHT : 552g
BODY : Aluminum
CAGE : Aluminum
SPINDLE : Cr-Mo
BEARING : DU / DU / Sealed
CLEAT : 98A
SIZE : 109.6 x 102 x 33.5 mm
ORIGIN : Taiwan



NEW

W-70

WEIGHT : 516g
BODY : Aluminum CNC machined
FINISH : ED black
SPINDLE : Cr-Mo
BEARING : DU / Sealed
CLEAT : 98A
SIZE : 104 x 89 x 30.1 mm
ORIGIN : Taiwan

**WAM-D10**

WEIGHT : 516g
BODY : Magnesium
FINISH : Painted
SPINDLE : Cr-Mo
BEARING : Needle / DU / Sealed
CLEAT : 98A
SIZE : 109.1 x 94.7 x 33.8 mm
ORIGIN : Taiwan

**B252**

WEIGHT : 300g
BODY : 6061 CNC Aluminum
FINISH : Anodized
SPINDLE : Cr-Mo
BEARING : DU / Sealed
SIZE : 108 x 106 x 17.5 mm
ORIGIN : Taiwan

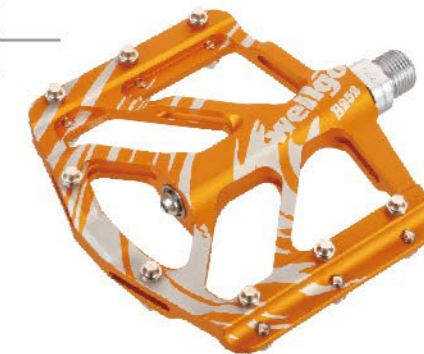
**B187**

WEIGHT : 306g
BODY : 6061 CNC Aluminum
FINISH : Anodized
SPINDLE : Cr-Mo
BEARING : DU / Sealed
SIZE : 108 x 106 x 17.8 mm
ORIGIN : Taiwan



NEW

B212

WEIGHT : 372g
BODY : 6061 CNC Aluminum
FINISH : Anodized
SPINDLE : Cr-Mo
BEARING : DU / Sealed
SIZE : 107 x 99.6 x 28.4 mm
ORIGIN : Taiwan



NEW

B257

WEIGHT : 352g
BODY : 6061 CNC Aluminum
FINISH : Anodized
SPINDLE : Cr-Mo
BEARING : DU / Sealed
SIZE : 103.5 x 100 x 21 mm
ORIGIN : Taiwan



RD

B030

WEIGHT : 398g
BODY : 6061 CNC Aluminum
FINISH : Anodized
SPINDLE : Cr-Mo
BEARING : DU / Sealed
SIZE : 109.5 x 100 x 21.9 mm
ORIGIN : Taiwan

**B184**

WEIGHT : 356g
BODY : 6061 CNC Aluminum
FINISH : Anodized
SPINDLE : Cr-Mo
BEARING : DU / Sealed
SIZE : 105.5 x 100 x 27 mm
ORIGIN : Taiwan

**B143**

WEIGHT : 384g
BODY : 6061 CNC Aluminum
FINISH : Anodized
SPINDLE : Cr-Mo
BEARING : DU / Sealed
SIZE : 107.3 x 100 x 26.1 mm
ORIGIN : Taiwan



RD

B219

WEIGHT : 415g
BODY : 6061 CNC Aluminum
FINISH : Anodized
SPINDLE : Cr-Mo
BEARING : DU / Sealed
SIZE : 108.7 x 106.7 x 25 mm
ORIGIN : Taiwan

**B281**

WEIGHT : 382g
BODY : 6061 CNC Aluminum
FINISH : Anodized
SPINDLE : Cr-Mo
BEARING : DU / Sealed
SIZE : 114 x 100 x 26.2 mm
ORIGIN : Taiwan



RD



B181

WEIGHT : 344g
BODY : 6061 Forged Aluminum
FINISH : Anodized
SPINDLE : Cr-Mo
BEARING : DU / Sealed
SIZE : 115 x 102 x 10 mm
ORIGIN : Taiwan

**MG2**

WEIGHT : 330g
BODY : Magnesium
FINISH : Painted
SPINDLE : Cr-Mo
BEARING : DU / Sealed
SIZE : 112.5 x 100 x 30.2 mm
ORIGIN : Taiwan

**MG21**

WEIGHT : 298g
BODY : Magnesium
FINISH : Painted
SPINDLE : Cr-Mo
BEARING : DU / Sealed
SIZE : 112 x 106 x 20.8 mm
ORIGIN : Taiwan & China

**MG6-AL**

WEIGHT : 362g
BODY : Aluminum
FINISH : ED black or painted
SPINDLE : Cr-Mo
BEARING : DU / Sealed
SIZE : 112 x 106 x 20.8 mm
ORIGIN : Taiwan

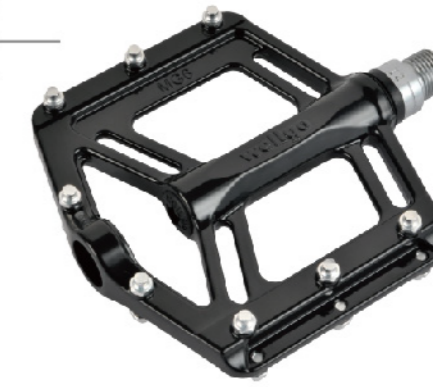
**MG-1**

WEIGHT : 366g
BODY : Magnesium
FINISH : Painted
SPINDLE : Cr-Mo
BEARING : DU / Sealed
SIZE : 114.6 x 106.2 x 30.8 mm
ORIGIN : Taiwan

**B233**

WEIGHT : 356g
BODY : Magnesium
FINISH : Painted
SPINDLE : Cr-Mo
BEARING : DU / Sealed
SIZE : 110.5 x 100 x 26 mm
ORIGIN : Taiwan

**B087B**

WEIGHT : 374g (Mg)
 450g (Al)
BODY : Aluminum / Magnesium
FINISH : ED black or Painted
SPINDLE : Cr-Mo
BEARING : DU / Sealed
SIZE : 109 x 100.5 x 26 mm
OPTION : B087 as Ball bearing with mold pin
 B087DU as 2DU with mold pin
ORIGIN : Taiwan & China

**MG32**

WEIGHT : 308g
BODY : Magnesium
FINISH : Painted
SPINDLE : Boron
BEARING : Polymer bearing
SIZE : 111.5 x 102 x 29.5 mm
ORIGIN : Taiwan

**MG3**

WEIGHT : 296g
BODY : Magnesium
FINISH : Painted
SPINDLE : Boron
BEARING : Polymer bearing
SIZE : 111.5 x 102 x 27.6 mm
OPTION : B249DU as Aluminum with mold pin
ORIGIN : Taiwan

**MG36**

WEIGHT : 320g
BODY : Magnesium
FINISH : Painted
SPINDLE : Boron
BEARING : Polymer bearing
SIZE : 111.5 x 102 x 26.2 mm
ORIGIN : Taiwan

**B180U**

WEIGHT : 410g
BODY : Aluminum
FINISH : ED black or Painted
SPINDLE : Cr-Mo
BEARING : Ball bearing
SIZE : 109.3 x 100 x 30 mm
OPTION : B180B as Sealed bearing version
 B180 as mold pin
ORIGIN : Taiwan

**B155**

WEIGHT : 420g
BODY : Aluminum
FINISH : ED black or Painted
SPINDLE : Cr-Mo
BEARING : Ball Bearing
SIZE : 108.5 x 100 x 28 mm
OPTION : B155B as Sealed bearing version
ORIGIN : Taiwan



B121

WEIGHT : 479g
BODY : Aluminum
FINISH : Barrel silver or ED black
SPINDLE : Cr-Mo
BEARING : Ball Bearing
SIZE : 112 x 100 x 30.5 mm
OPTION : B121B as Sealed bearing version
ORIGIN : Taiwan

**B133**

WEIGHT : 410g
BODY : Aluminum
FINISH : Barrel silver or ED black
SPINDLE : Cr-Mo
BEARING : Ball Bearing
SIZE : 105.4 x 90.2 x 28 mm
OPTION : B133B as Sealed bearing version
ORIGIN : Taiwan

**B223BP**

WEIGHT : 326g
BODY : PC translucent color
SPINDLE : Cr-Mo
BEARING : DU / Sealed
SIZE : 111 x 100 x 27 mm
OPTION : B223P as Ball bearing version
ORIGIN : Taiwan

**B109P**

WEIGHT : 330g(PP)
 370g(PC)
 398g(NYLON)
BODY : PC Translucent color
SPINDLE : Cr-Mo
BEARING : Ball bearing
SIZE : 111 x 102.5 x 30 mm
OPTION : B109N as Nylon with fiber
 B109 as Plastic
ORIGIN : Taiwan

**B107P**

WEIGHT : 374g
BODY : PC Translucent color
SPINDLE : Cr-Mo
BEARING : Ball bearing
SIZE : 112 x 102.4 x 28.4 mm
ORIGIN : Taiwan

**B107N**

WEIGHT : 386g
BODY : Nylon with fiber
SPINDLE : Cr-Mo
BEARING : Ball bearing
SIZE : 112 x 102.4 x 28.4 mm
OPTION : Available with Reflector design
ORIGIN : Taiwan

**B152**

WEIGHT : 314g(PP)
 366g(NYLON)
BODY : Plastic
SPINDLE : Cr-Mo
BEARING : Ball bearing
SIZE : 101 x 90 x 27.5 mm
OPTION : B152N as Nylon with fiber
ORIGIN : Taiwan

**B197**

WEIGHT : 270g
BODY : Plastic black
SPINDLE : Cr-Mo
BEARING : Ball bearing
SIZE : 106 x 90 x 31.7 mm
ORIGIN : Taiwan & China

**B123**

WEIGHT : 228g
BODY : One piece plastic black
SPINDLE : Cr-Mo
BEARING : Ball bearing
SIZE : 111 x 98.7 x 26.5 mm
ORIGIN : Taiwan

**B088**

WEIGHT : 306g
BODY : Plastic black
SPINDLE : Cr-Mo
BEARING : Ball bearing
SIZE : 112 x 102 x 28.5 mm
ORIGIN : Taiwan & China

**Color option for PC material**

Black



291C



Clear



347C



186C

Color option for nylon material

Black



White



802C



186C



QRDII-C231B LOCKING PEDAL

WEIGHT : 300g (Mg)
379g (Al)
BODY : Aluminum
FINISH : ED black or painted
SPINDLE : Cr-Mo
BEARING : DU / Sealed
SIZE : 102 x 100 x 26 mm
ORIGIN : Taiwan

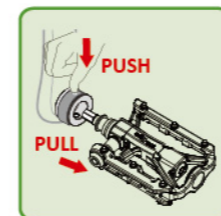
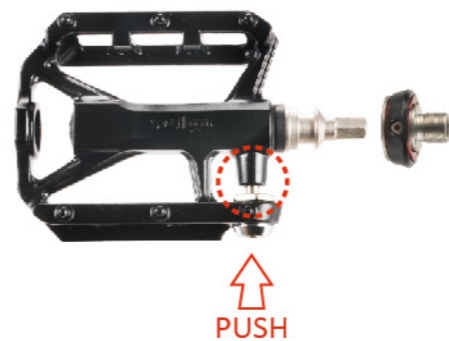

The pedal could be locking at front or rear spoke as a locker

FEATURES:

To solve the noising sound while riding on bumpy road and the inconvenience for carry locks outdoor, wellgo locking pedal has been connected the pedal and the lock.

It offers the rider to easily remove the pedal and put it onto the spoke as a lock. Locking pedal design is compatible to all bikes.



C176B

WEIGHT : 344g
BODY : Aluminum
FINISH : ED black
CAGE : Aluminum
SPINDLE : Cr-Mo
BEARING : DU / Sealed
CLEAT : 98A
SIZE : 104 x 63.2 x 28 mm
OPTION : C176 as Ball bearing version
ORIGIN : Taiwan

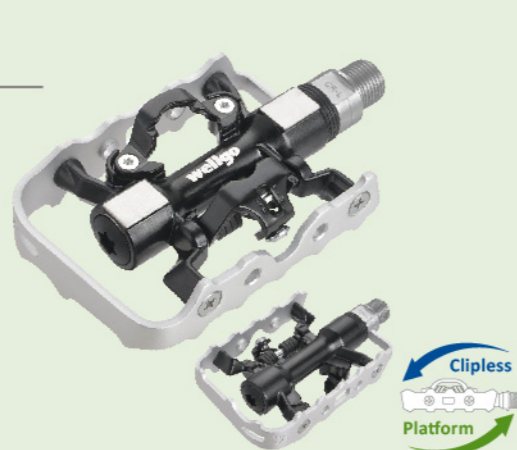

FEATURES:

The waving linear design on the body makes the design more vitality and out of the conventional concept, the extended stepping width surface also improves the riding comfort.

The tension screw could be adjusted as per rider's demands and the indicator design gives awareness to the adjusting stages. In addition, the outer cage design also provides better traction while riding.

C002B

WEIGHT : 395g
BODY : Aluminum
FINISH : Barrel silver
CAGE : Aluminum
SPINDLE : Cr-Mo
BEARING : 2 Sealed
CLEAT : 98A
SIZE : 101.7 x 65.4 x 29.8 mm
OPTION : C002 as Ball bearing version
ORIGIN : Taiwan

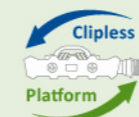
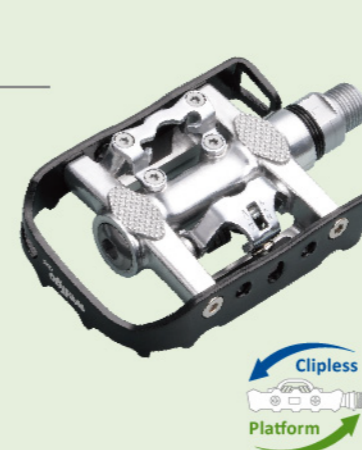

WPD-M17C

WEIGHT : 352g
BODY : Aluminum
FINISH : Barrel silver
CAGE : Aluminum
SPINDLE : Cr-Mo
BEARING : DU / Sealed
CLEAT : 98A
SIZE : 100.8 x 65.2 x 27.2 mm
ORIGIN : Taiwan



WPD-95B

WEIGHT : 446g
BODY : Aluminum
FINISH : Barrel silver
CAGE : Aluminum
SPINDLE : Cr-Mo
BEARING : DU / Sealed
CLEAT : 98A
SIZE : 101.7 x 65.4 x 29.8 mm
ORIGIN : Taiwan



C293

WEIGHT : 316g
BODY : 6061 CNC Aluminum
FINISH : Anodized W/Sand Paper
SPINDLE : Cr-Mo
BEARING : DU / Sealed
SIZE : 103 x 77 x 18.6 mm
ORIGIN : Taiwan



NEW

C271

WEIGHT : 220g
BODY : 6061 CNC Aluminum
FINISH : Anodized
SPINDLE : Cr-Mo
BEARING : DU / Sealed
SIZE : 95.5 x 78 x 24.5 mm
ORIGIN : Taiwan



C266

WEIGHT : 230g
BODY : 6061 CNC Aluminum
FINISH : Anodized
SPINDLE : Cr-Mo
BEARING : DU / Sealed
SIZE : 90 x 78 x 25 mm
ORIGIN : Taiwan



C238

WEIGHT : 280g
BODY : 6061 CNC Aluminum
FINISH : Anodized
CAGE : Aluminum
SPINDLE : Cr-Mo
BEARING : DU / Sealed
SIZE : 110 x 67.2 x 23 mm
ORIGIN : Taiwan



OPEN AS THE STAND

C260

WEIGHT : 188g (Ti)
 230g (Cr-Mo)
BODY : 6061 CNC Aluminum
FINISH : Anodized
SPINDLE : Cr-Mo or Ti
BEARING : DU / Sealed
SIZE : 82 x 100 x 24 mm
ORIGIN : Taiwan

**C006**

WEIGHT : 214g
BODY : 6061 CNC Aluminum
FINISH : Anodized
SPINDLE : Cr-Mo
BEARING : DU / Sealed
SIZE : 95 x 61.5 x 22.9 mm
ORIGIN : Taiwan

**C161**

WEIGHT : 282g
BODY : 6061 CNC Aluminum
FINISH : Anodized
SPINDLE : Cr-Mo
BEARING : DU / Sealed
SIZE : 108 x 78 x 26 mm
ORIGIN : Taiwan

**C237**

WEIGHT : 236g
BODY : 6061 Forged Aluminum
FINISH : Anodized
SPINDLE : Cr-Mo
BEARING : DU / Sealed
SIZE : 102 x 74 x 20.8 mm
ORIGIN : Taiwan

**C227DU**

WEIGHT : 326g
BODY : Aluminum
FINISH : ED black or painted
SPINDLE : Boron
BEARING : Polymer bearing
SIZE : 99 x 84 x 26.5 mm
OPTION : C227B as Sealed bearing version
ORIGIN : Taiwan

**C254DU**

WEIGHT : 434g
BODY : Aluminum
FINISH : Barrel silver W/Sand Paper
SPINDLE : Boron
BEARING : Polymer bearing
SIZE : 106 x 75 x 27 mm
OPTION : C254B as Sealed bearing version
ORIGIN : Taiwan

**C276**

WEIGHT : 378g
BODY : Aluminum
FINISH : Barrel silver
CAGE : Aluminum
SPINDLE : Boron
BEARING : Ball bearing
SIZE : 102.5 x 70.5 x 28 mm
ORIGIN : Taiwan

**C128**

WEIGHT : 250g (Al)
 309g (Steel)
BODY : Aluminum
FINISH : Barrel silver
CAGE : Aluminum or Steel
SPINDLE : Cr-Mo
BEARING : Ball bearing
SIZE : 106.3 x 63 x 24 mm
OPTION : C128B as Sealed bearing version
 C128DU as 2DU version
ORIGIN : Taiwan & China

**C127**

WEIGHT : 226g (Al)
 295g (Steel)
BODY : Plastic black
CAGE : Aluminum or steel
SPINDLE : Cr-Mo
BEARING : Ball bearing
SIZE : 106.3 x 63 x 24 mm
OPTION : C127DU as 2DU version
ORIGIN : Taiwan & China



C32B

WEIGHT : 324g
BODY : Aluminum with kraton top
FINISH : Barrel silver
SPINDLE : Cr-Mo
BEARING : DU / Sealed
SIZE : 102.9 x 69.6 x 24.2 mm
OPTION : C32 as Ball bearing version
ORIGIN : Taiwan



C016

WEIGHT : 460g
BODY : Aluminum with kraton top
FINISH : Barrel silver
SPINDLE : Cr-Mo
BEARING : Ball bearing
SIZE : 106 x 91 x 30 mm
OPTION : C016B as Sealed bearing version
ORIGIN : Taiwan



F265

WEIGHT : 436g
BODY : Aluminum
FINISH : Barrel silver or ED black
CAGE : Aluminum
SPINDLE : Boron
BEARING : Polymer bearing
SIZE : 105 x 89.3 x 24.2 mm
ORIGIN : Taiwan & China



F268

WEIGHT : 370g
BODY : Aluminum
FINISH : Barrel silver or ED black
CAGE : PC black
SPINDLE : Boron
BEARING : Polymer bearing
SIZE : 104.7 x 84 x 28.2 mm
ORIGIN : Taiwan & China



C097

WEIGHT : 244g
BODY : Plastic with kraton top
SPINDLE : Cr-Mo
BEARING : Ball bearing
SIZE : 103 x 79.5 x 24 mm
ORIGIN : Taiwan



C157

WEIGHT : 270g
BODY : Plastic with kraton top
SPINDLE : Boron
BEARING : Ball bearing
SIZE : 99 x 63.3 x 24.5 mm
ORIGIN : Taiwan & China



F278

WEIGHT : 396g
BODY : PC black
CAGE : Aluminum
SPINDLE : Boron
BEARING : Polymer bearing
SIZE : 104.7 x 84 x 28.2 mm
ORIGIN : Taiwan & China

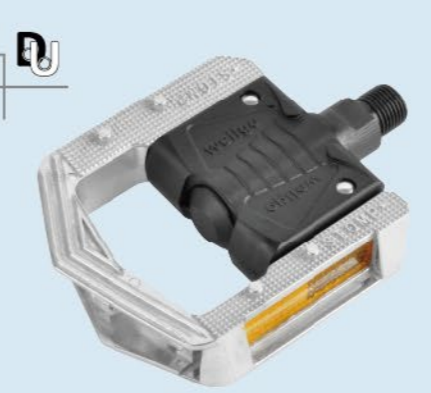

F284

WEIGHT : 328g
BODY : PC black
CAGE : PC black
SPINDLE : Boron
BEARING : Polymer bearing
SIZE : 104.7 x 84 x 28.2 mm
ORIGIN : Taiwan & China



C246DU

WEIGHT : 246g
BODY : One piece plastic black
SPINDLE : Boron
BEARING : Polymer bearing
SIZE : 106.3 x 80.9 x 23.8 mm
ORIGIN : Taiwan & China



F178DU

WEIGHT : 328g
BODY : PC black
CAGE : PC black
SPINDLE : Boron
BEARING : Polymer bearing
SIZE : 98 x 72.2 x 26 mm
ORIGIN : Taiwan & China

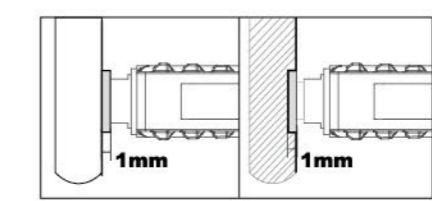

The washer could offer better contact while install the pedal into crank arm.

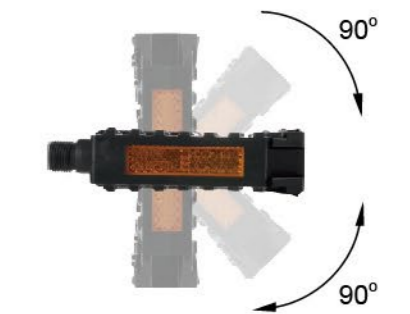

E229B

WEIGHT : 776g
BODY : Aluminum
FINISH : ED black
SPINDLE : Cr-Mo
BEARING : 3 Sealed
CLEAT : 98A
SIZE : 100.5 x 79 x 34 mm
ORIGIN : Taiwan

**WPD-E14B**

WEIGHT : 832g
BODY : Aluminum with kraton top
FINISH : Barrel silver
SPINDLE : Cr-Mo
BEARING : DU / Needle / Sealed
CLEAT : 98A
SIZE : 109 x 80.2 x 34.8 mm
OPTION : E14B as W/O QBS
 WPD-E14 as Ball bearing version
ORIGIN : Taiwan

**E14B**

WEIGHT : 728g
BODY : Aluminum
FINISH : Barrel silver with kraton top
SPINDLE : Cr-Mo
BEARING : DU / Needle / Sealed
CLEAT : 98A
SIZE : 109 x 80.2 x 34.8 mm
OPTION : WPD-E14B as W/QBS
 E14 as Ball version
ORIGIN : Taiwan

**E179**

WEIGHT : 578g
BODY : Aluminum
FINISH : Barrel silver
SPINDLE : Cr-Mo
BEARING : Ball bearing
CAGE : Steel / ED black
SIZE : 113 x 62.6 x 30 mm
OPTION : Toe clip & strap mountable
ORIGIN : Taiwan

**WPD-E003B**

WEIGHT : 774g
BODY : Aluminum
FINISH : ED black
SPINDLE : Cr-Mo
BEARING : 3 Sealed
CLEAT : 98A
SIZE : 102.4 x 72.4 x 34.9 mm
OPTION : E003B as W/O QBS
 WPD-E003 as Ball bearing version
ORIGIN : Taiwan

**E003B**

WEIGHT : 672g
BODY : Aluminum
FINISH : ED black
SPINDLE : Cr-Mo
BEARING : 3 Sealed
CLEAT : 98A
SIZE : 102.4 x 72.4 x 34.9 mm
OPTION : WPD-E003B as W/QBS
 E003 as Ball bearing version
ORIGIN : Taiwan

**EX-13**

WEIGHT : 1012g
BODY : Plastic black with Pu Strap
SPINDLE : Boron
BEARING : Ball bearing
SIZE : 115.2 x 130.9 x 51 mm
ORIGIN : Taiwan



1 Push down the buckle

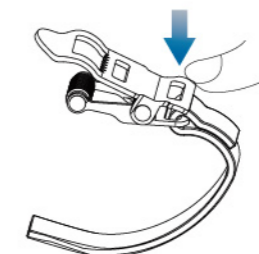

2 Have the strap through the buckle

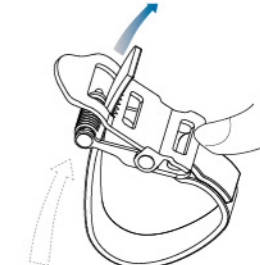

3 Release the buckle

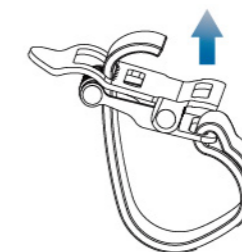

4 Have the strap go through the upper hole of the buckle to hold the strap

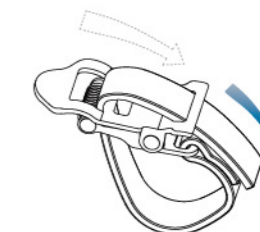

LU-P21

WEIGHT : 288g
BODY : One piece plastic black
SPINDLE : Boron
BEARING : Ball bearing
SIZE : 90 x 65 x 31 mm
ORIGIN : Taiwan & China

**LU-P17**

WEIGHT : 298g
BODY : One piece plastic black
SPINDLE : Boron
BEARING : Ball bearing
SIZE : 92 x 85.5 x 29.5 mm
ORIGIN : Taiwan & China

**LU-873**

WEIGHT : 252g
BODY : One piece plastic black
FINISH : Boron
SPINDLE : Ball bearing
BEARING : 90 x 65 x 29 mm
SIZE : LU-873NB as Ball-less version
ORIGIN : Taiwan & China

**C283**

WEIGHT : 208g
BODY : Plastic black
SPINDLE : Boron
BEARING : Ball-less
SIZE : 88.5 x 67.7 x 24.8 mm
ORIGIN : Taiwan & China



NEW

LU-937NB

WEIGHT : 228g
BODY : One piece plastic black
SPINDLE : Steel
BEARING : Ball-less
SIZE : 95 x 64 x 27 mm
ORIGIN : Taiwan & China

**LU-892DU**

WEIGHT : 290g
BODY : One piece plastic black
SPINDLE : Boron
BEARING : Polymer bearing
SIZE : 99 x 75 x 31 mm
OPTION : LU-892 as Ball bearing version
ORIGIN : Taiwan & China

**LU-866**

WEIGHT : 336g
BODY : One piece plastic black
SPINDLE : Boron
BEARING : Ball bearing
SIZE : 106 x 71.5 x 36.5 mm
ORIGIN : Taiwan & China

**LU-894**

WEIGHT : 322g
BODY : One piece plastic black
SPINDLE : Boron
BEARING : Ball bearing
SIZE : 108.5 x 68.5 x 26 mm
ORIGIN : Taiwan & China

**LU-968**

WEIGHT : 282g
BODY : One piece plastic black
SPINDLE : Boron
BEARING : Ball bearing
SIZE : 95.5 x 81.5 x 29.5 mm
ORIGIN : Taiwan & China

**B267**

WEIGHT : 288g(PP)
 : 336g(NYLON)
BODY : Plastic black
SPINDLE : Cr-Mo
BEARING : Ball bearing
CAGE : 106.3 x 93.9 x 27.6 mm
SIZE : B267N as Nylon with fiber
ORIGIN : Taiwan



NEW

LU-204

WEIGHT : 416g
BODY : Aluminum
FINISH : ED black or painted
SPINDLE : Boron
BEARING : Ball bearing
SIZE : 94.2 x 84.2 x 29.8 mm
ORIGIN : Taiwan & China



LU-964

WEIGHT : 344g (Al)
 425g (Steel)
BODY : Aluminum
FINISH : Barrel silver
CAGE : Aluminum or Steel
SPINDLE : Boron
BEARING : Ball bearing
SIZE : 102 x 70 x 32 mm
ORIGIN : Taiwan & China



LU-C29G

WEIGHT : 374g
BODY : Aluminum
FINISH : ED black with CNC machined
SPINDLE : Boron
BEARING : Ball bearing
SIZE : 101.8 x 66.8 x 28 mm
ORIGIN : Taiwan



LU-C3

WEIGHT : 296g(Al)
 386g(Steel)
BODY : Plastic black
CAGE : Aluminum or Steel
SPINDLE : Boron
BEARING : Ball bearing
SIZE : 103 x 63 x 28 mm
ORIGIN : Taiwan & China



LU-207

WEIGHT : 326g
BODY : One piece plastic black
SPINDLE : Boron
BEARING : Ball bearing
SIZE : 105.9 x 80.8 x 29.5 mm
ORIGIN : Taiwan & China



LU-948

WEIGHT : 304g (Al)
 388g (Steel)
BODY : Plastic black
CAGE : Aluminum or Steel
SPINDLE : Boron
BEARING : Ball bearing
SIZE : 98 x 74 x 30 mm
ORIGIN : Taiwan & China

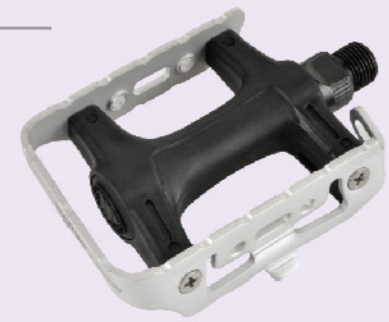

R-11

WEIGHT : 362g
BODY : Plastic black
CAGE : Aluminum
SPINDLE : Boron
BEARING : Ball bearing
SIZE : 99 x 63 x 29 mm
ORIGIN : Taiwan & China



LU-209

WEIGHT : 436g
BODY : Aluminum
FINISH : Barrel silver
SPINDLE : Boron
BEARING : Ball bearing
SIZE : 87.2 x 86.4 x 29.8 mm
ORIGIN : Taiwan & China



LU-975

WEIGHT : 464g
BODY : Aluminum with kraton top
FINISH : Barrel silver
SPINDLE : Boron
BEARING : Ball bearing
SIZE : 103 x 71.5 x 31 mm
ORIGIN : Taiwan & China



LU-206

WEIGHT : 366g
BODY : Plastic with kraton top
SPINDLE : Boron
BEARING : Ball bearing
SIZE : 110 x 84 x 32 mm
ORIGIN : Taiwan & China



LU-884

WEIGHT : 392g
BODY : Plastic with kraton top
SPINDLE : Boron
BEARING : Ball bearing
SIZE : 105 x 72 x 32 mm
ORIGIN : Taiwan & China



LU-990

WEIGHT : 406g
BODY : Plastic with kraton top
SPINDLE : Boron
BEARING : Ball bearing
SIZE : 106.5 x 94 x 33.2 mm
ORIGIN : Taiwan & China



LU-313

WEIGHT : 480g
BODY : Aluminum
FINISH : ED black or painted
SPINDLE : Boron
BEARING : Ball bearing
SIZE : 109.5 x 105 x 30 mm
ORIGIN : Taiwan & China



LU-B78

WEIGHT : 350g
BODY : One piece plastic black
SPINDLE : Boron
BEARING : Ball bearing
SIZE : 100.5 X 95.5 X 32 mm
ORIGIN : Taiwan & China



LU-984

WEIGHT : 316g
BODY : One piece plastic black
SPINDLE : Boron
BEARING : Ball bearing
SIZE : 107 X 95.5 X 28 mm
OPTION : LU-984DU as 2DU version
ORIGIN : Taiwan & China



LU-205

WEIGHT : 336g
BODY : One piece plastic black
SPINDLE : Boron
BEARING : Ball bearing
SIZE : 111.5 x 99 x 31.5 mm
ORIGIN : Taiwan & China



LU-P9

WEIGHT : 344g
BODY : One piece plastic black
SPINDLE : Boron
BEARING : Ball bearing
SIZE : 108 x 105 x 32.5 mm
ORIGIN : Taiwan & China



TOE CLIP

MT-3

Double supportive design with instep guard.
 MT-3 size L,
 MT-4 size S,
 MT-5 size M.



MT-6

Large supportive design with instep guard.



MT-7

Mini toe-clip
 Size: 82.7 x 53.8mm



RP-1

Classic road racing toe-clip
 Size: M / L



MT-10

Strapless toe-clip for technical or casual riding.



MT-11

Large supportive design with instep guard and built-in reflector.
 MT-11 size L,
 MT-12 size M.



MT-14

Double supportive design with built-in reflector.
 MT-13 size M,
 MT-14 size L.



MT-19

Size: S / M / L / XL



NYLON TOE-STRAP

W-4

Nylon toe-strap with heavy-duty buckle.



Black

W-2



Black

STRAP

W8



Black



PC (Strap mountable)

SPINDLE

K001

Axle replacement kit.

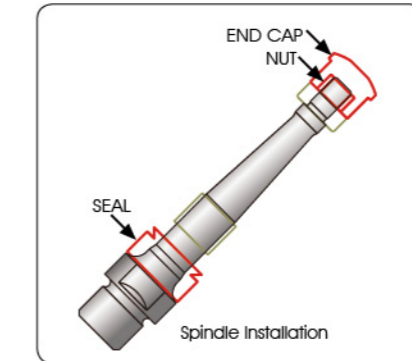

Spindle Installation

K004

Bearing replacement kit.

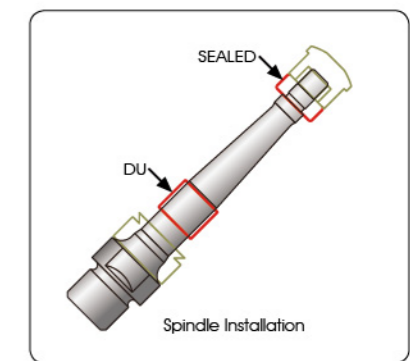

Spindle Installation



WRENCH



PIN OPTIONS

Color: JY-001 JY-002 JY-023 JY-017 JY-007 JY-005

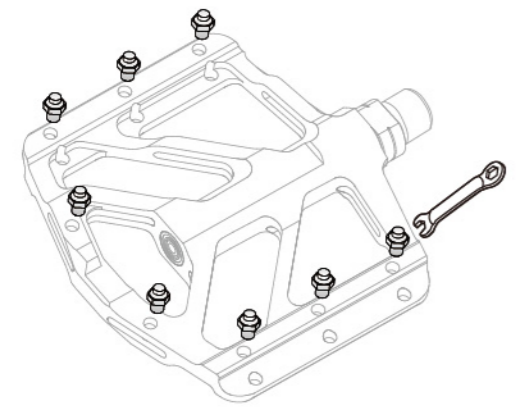
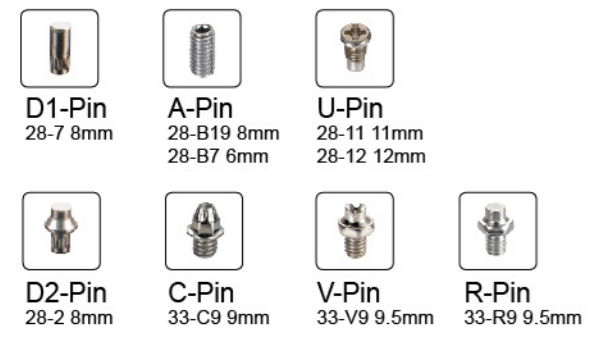

REFLECTOR

RR1-5

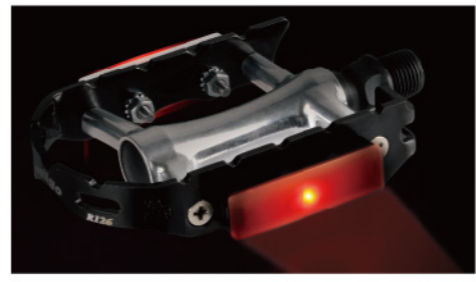

BOLT TYPE
Bolt-on reflector set for standard MTB pedals.
25 g/pr



SNAP ON
Snap-on reflector set.



LONG SNAP ON
Extra-long snap-on reflector set.

How to use 98A Reflector platform



98A-2 (60 g/pr)
Reflector for pedal
715 · 801 · 823 · M19 · M717 · M919 · MG8



98A-3 (60 g/pr)
Reflector for pedal
M094 · M18 · W01 · XMF3

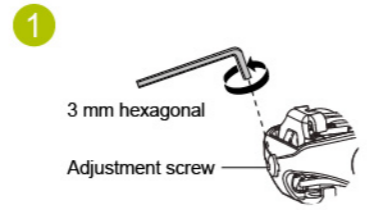

Use a 3mm hexagonal wrench to adjust the spring tension to the lowest tension.

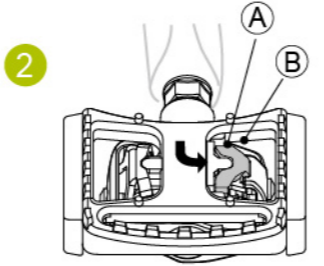

First, insert (A) point of the reflector platform into the front side of the pedal claw.

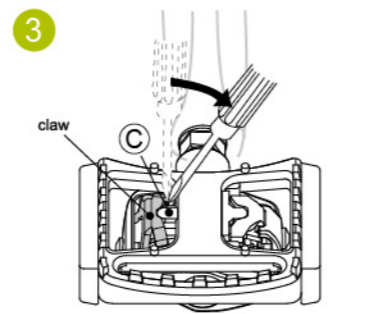

Use a straight (flat) screwdriver to push the back claw backwards for easier access to the reflector platform.

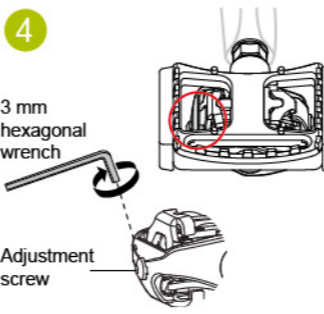

Once the reflector platforms are installed to the pedal, please adjust the spring tension to fit your need.

CLEAT



98R
Cleat kit
4 degree float
77 g/pr



RC8
New cleat design for mountain clipless pedal to be assembled on LOOK style shoes.
MATERIAL : Cr-Mo
126 g/pr



RC-3
Cleat kit for WAM-R2 and R4.
4 degree float
105 g/pr



98A
Cleat kit with improved mud clearance features.
4 degree float
52 g/pr



99A
Cleat kit
4 degree float
49 g/pr



CLEAT PACKAGE



RC-7A
Cleat kit for R096, R168 & E148
9 degree lateral float
82 g/pr



RC-7B
Cleat kit for R096, R168 & E148
6 degree lateral float
82 g/pr



RC-7C
Cleat kit for R096, R168 & E148
0 degree lateral float
82 g/pr

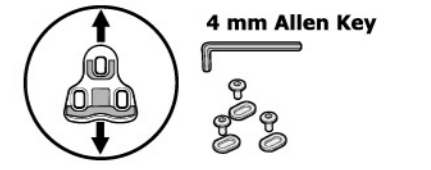

RC-5
Cleat kit for WAM-R1, R3 and MG-9, W40, CR-1.
9 degree lateral float
90 g/pr



RC-6
Cleat kit for WAM-R1, R3 and MG-9, W40, CR-1.
0 degree lateral float
90 g/pr

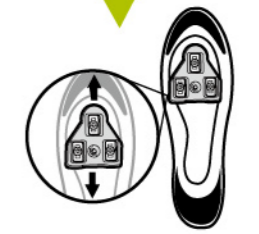

WELLGO PEDAL'S CORP.

No.3, Gong 7th Road, Youth Ind.Park, Dajia Dist.,Taichung City 437, Taiwan
TEL: 886-4-26816991-5 HTTP: //www.wellgopedal.com
FAX: 886-4-2681-6988, 2681-6998 E-MAIL: wd@wellgopedal.com

SHANGHAI FACTORY

No.103, Yuehd-Ho South Road Economic & Technical
Development Zone, Kunshan, Jiangsu, China
TEL: 86-512-57701991-4 HTTP: //www.wellgopedal.cn
FAX: 86-512-57701995 E-MAIL: wellgo@wellgopedal.cn

