

wellgo

2018



SYMBOL



MTB

05

ROAD

11

PLATFORM

16

CITY / TREKKING

22

FOLDING

30

YOUTH

32

EXERCISER

35

CLASSIC

37

ACCESSORIES

39

HRH01

WEIGHT 25g
 Material Nylon fiber overmolded steel
 BATTERY CR2032 (3V)
 SIZE 64 x 29 x 14.4 mm
 ORIGIN Taiwan



NEW

Universal Cadence Sensor



Rhythm, the latest universal cadence sensor which can be used on any type of pedals in the market. It can be directly assembled with the pedal which means there won't be any extra wires on your bike frame. It's easy to use function makes monitoring your status much easier.



- 2.4g ANT+ / BLE 4.0 compatible
 - 200 hrs with CR2032 button battery



NEW R.B.

Polymer bearing + Sealed



M255RB



M298RB



M259RB



C235RB

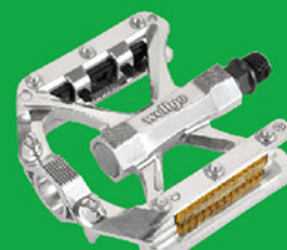

B230RB



Polymer bearing

Sealed

2DU

Polymer bearing x 2



M248DU



R198



C280DU



C172DU



B249DU



Polymer bearing

Polymer bearing

M111

WEIGHT	228g
BODY	6061 Forged Aluminum
FINISH	Anodized
SPINDLE	Cr-Mo
BEARING	DU / Sealed
SIZE	99 x 61 x 18 mm
ORIGIN	Taiwan

**M138**

WEIGHT	238g (Mg) 288g (Al)
BODY	Aluminum / Magnesium
FINISH	ED black or painted
SPINDLE	Cr-Mo
BEARING	DU / Sealed
SIZE	102 x 68 x 29 mm
ORIGIN	Taiwan

**LU-C27G**

WEIGHT	270g
BODY	Aluminum
FINISH	ED black with CNC machined
SPINDLE	Cr-Mo
BEARING	Ball bearing
SIZE	101.5 x 63.3 x 23.3 mm
OPTION	LU-C27GB as Sealed bearing LU-C27 as Cage without machined
ORIGIN	Taiwan

**M20**

WEIGHT	248g (Al) 303g (Steel)
BODY	Aluminum
FINISH	Barrel silver
CAGE	Aluminum or Steel
SPINDLE	Cr-Mo
BEARING	DU / Sealed
SIZE	101.1 x 63 x 24 mm
ORIGIN	Taiwan

**M255RB**

WEIGHT	272g
BODY	Aluminum
FINISH	Barrel silver
CAGE	Aluminum
SPINDLE	Boron
BEARING	DU / Sealed
SIZE	102.4 x 63.2 x 24 mm
ORIGIN	Taiwan

**M298RB**

WEIGHT	280g
BODY	Aluminum
FINISH	Barrel silver
CAGE	Aluminum
SPINDLE	Boron
BEARING	DU / Sealed
SIZE	102.3 x 63.4 x 24.3 mm
ORIGIN	Taiwan

**M259RB**

WEIGHT	353g
BODY	Aluminum
FINISH	Barrel silver
SPINDLE	Boron
BEARING	DU / Sealed
SIZE	109.1 x 74 x 25 mm
ORIGIN	Taiwan

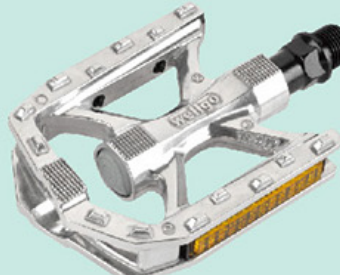
**M224G**

WEIGHT	315g
BODY	Aluminum
FINISH	ED black with CNC machined
SPINDLE	Boron
BEARING	Ball bearing
SIZE	102.5 x 66 x 25 mm
OPTION	M224GB as Sealed bearing version M224GDU as 2DU version
ORIGIN	Taiwan & China

**M272DU**

WEIGHT	240g
BODY	Aluminum
FINISH	Barrel silver
CAGE	Aluminum
SPINDLE	Boron
BEARING	Polymer bearing
SIZE	101 x 62.6 x 24 mm
ORIGIN	Taiwan & China

**M195DU**

WEIGHT	332g
BODY	Aluminum
FINISH	Barrel silver
SPINDLE	Boron
BEARING	Polymer bearing
SIZE	100 x 100 x 26.5 mm
OPTION	M195 as Ball bearing version M195B as Sealed bearing version
ORIGIN	Taiwan & China

**M273DU**

WEIGHT	216g
BODY	Plastic black
CAGE	Aluminum
SPINDLE	Boron
BEARING	Polymer bearing
SIZE	101 x 62.6 x 24 mm
ORIGIN	Taiwan & China

**LU-895DU**

WEIGHT	223g
BODY	One piece plastic black
SPINDLE	Boron
BEARING	Polymer bearing
SIZE	105.5 x 86 x 23 mm
ORIGIN	Taiwan & China





NEW

WPD-823DU

WEIGHT	368g
BODY	Aluminum
FINISH	ED black or painted
SPINDLE	Cr-Mo
BEARING	Polymer bearing
CLEAT	98A
SIZE	81.5 x 64 x 35 mm
OPTION	WPD-823 as Ball bearing version
ORIGIN	Taiwan



NEW



1. One piece front clamp / plate design provides the clip in and out movement more easy.
2. With the plate protect, could prevent the parts to be scratched while movement.

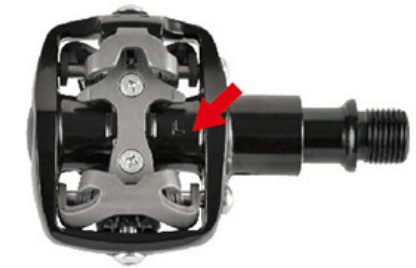

High impact one piece body construction.

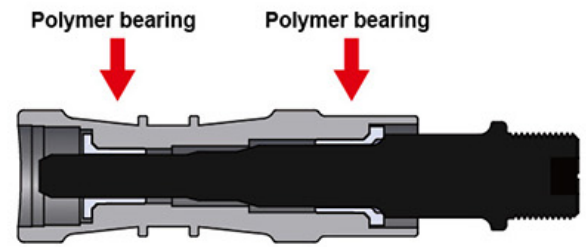

2DU system provides better life time.

M279

WEIGHT	350g
BODY	Aluminum
FINISH	ED black or painted
SPINDLE	Cr-Mo
BEARING	Polymer bearing
CLEAT	98A
SIZE	80 x 82 x 38 mm
ORIGIN	Taiwan



FEATURES:

1. Unique one piece claw design offers better clip release function.
2. Tension indicator with anti-loose design prevents losing screws accidentally.
3. 2DU cartridge sleeve design makes easy replacement ability.

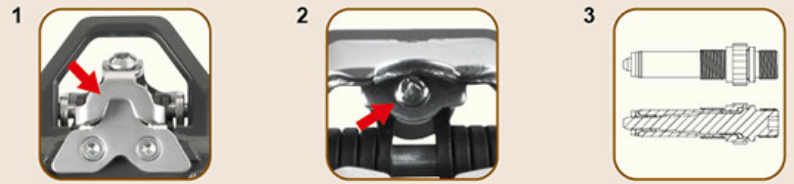

M250

WEIGHT	324g
BODY	Aluminum
FINISH	ED black or painted
SPINDLE	Cr-Mo
BEARING	DU / Sealed
CLEAT	98A
SIZE	80 x 61 x 33.5 mm
ORIGIN	Taiwan

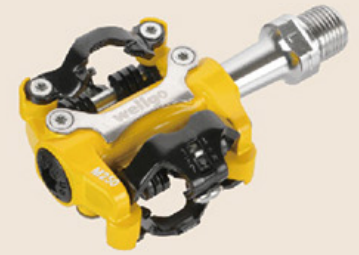

M177B

WEIGHT	260g (Ti/Mg) 300g (Cr-Mo/Mg) 334g (Cr-Mo/Al)
BODY	Aluminum / Magnesium
FINISH	ED black or painted
SPINDLE	Cr-Mo or Ti
BEARING	DU / Sealed
CLEAT	98A
SIZE	84 x 64.5 x 34 mm
ORIGIN	Taiwan



W-01

WEIGHT	237g (Ti/Mg) 300g (Cr-Mo/Al)
BODY	Aluminum / Magnesium
FINISH	ED black or painted
SPINDLE	Cr-Mo or Ti
BEARING	DU / Sealed
CLEAT	98A
SIZE	80.1 x 66 x 30.6 mm
ORIGIN	Taiwan



WAM-M19

WEIGHT	252g (Ti/Mg) 300g (Cr-Mo/Al)
BODY	Aluminum / Magnesium
FINISH	ED black or painted
SPINDLE	Cr-Mo or Ti
BEARING	DU / Sealed
CLEAT	98A
SIZE	79.8 x 59.8 x 30.1 mm
ORIGIN	Taiwan



M094B

WEIGHT	300g (Mg) 318g (Al)
BODY	Aluminum / Magnesium
FINISH	ED black or painted
SPINDLE	Cr-Mo
BEARING	DU / Sealed
CLEAT	98A
SIZE	80.9 x 65.3 x 33.8 mm
OPTION	M094 as Ball bearing version
ORIGIN	Taiwan



WAM-M919

WEIGHT	340g
BODY	Aluminum
FINISH	ED black or painted
SPINDLE	Cr-Mo
BEARING	Ball bearing
CLEAT	98A
SIZE	83.8 x 58.9 x 35.5 mm
ORIGIN	Taiwan





M151



WEIGHT	270g
BODY	6061 CNC Aluminum
FINISH	Anodized
CAGE	Aluminum
SPINDLE	Cr-Mo
BEARING	DU / Sealed
SIZE	107 x 60 x 22 mm
ORIGIN	Taiwan



Multi Function Pedal



★ Adjustable cage offers different size to meet people's needs.

Patented Pedal

M384157
CN201020101444.1

M21

WEIGHT	238g (Al) 293g (Steel)
BODY	Aluminum
FINISH	Barrel silver
CAGE	Aluminum or Steel
SPINDLE	Cr-Mo
BEARING	Ball bearing
SIZE	100.7 x 63 x 24 mm
ORIGIN	Taiwan



M248DU



WEIGHT	254g (Al) 312g (Steel)
BODY	Aluminum
FINISH	Barrel silver
CAGE	Aluminum or Steel
SPINDLE	Boron
BEARING	Polymer bearing
SIZE	99.7 x 63.2 x 23.5 mm
ORIGIN	Taiwan & China



M194



WEIGHT	243g
BODY	6061 CNC Aluminum
FINISH	Anodized
SPINDLE	Cr-Mo
BEARING	DU / Sealed
SIZE	100 x 99.3 x 23 mm
ORIGIN	Taiwan



M149



WEIGHT	248g (Al) 308g (Steel)
BODY	Aluminum
FINISH	Barrel silver
CAGE	Aluminum or Steel
SPINDLE	Cr-Mo
BEARING	Ball bearing
SIZE	97 x 63 x 24 mm
OPTION	M149B as Sealed bearing version M149DU as 2DU version
ORIGIN	Taiwan & China



M21

WEIGHT	238g (Al) 293g (Steel)
BODY	Aluminum
FINISH	Barrel silver
CAGE	Aluminum or Steel
SPINDLE	Cr-Mo
BEARING	Ball bearing
SIZE	100.7 x 63 x 24 mm
ORIGIN	Taiwan



M248DU



WEIGHT	254g (Al) 312g (Steel)
BODY	Aluminum
FINISH	Barrel silver
CAGE	Aluminum or Steel
SPINDLE	Boron
BEARING	Polymer bearing
SIZE	99.7 x 63.2 x 23.5 mm
ORIGIN	Taiwan & China



M141DU



WEIGHT	246g (Al) 301g (Steel)
BODY	Plastic black
CAGE	Aluminum or Steel
SPINDLE	Boron
BEARING	Polymer bearing
SIZE	105.3 x 63 x 24 mm
OPTION	M141 as Ball bearing version
ORIGIN	Taiwan & China

Snap in toe clip system.



M270DU



WEIGHT	232g (Al) 286g (Steel)
BODY	Plastic black
CAGE	Aluminum or Steel
SPINDLE	Boron
BEARING	Polymer bearing
SIZE	100 x 63.2 x 24 mm
ORIGIN	Taiwan



M085DU



WEIGHT	240g (Al) 296g (Steel)
BODY	Plastic black
CAGE	Aluminum or Steel
SPINDLE	Boron
BEARING	Polymer bearing
SIZE	99 x 63 x 24 mm
OPTION	M085 as Ball bearing version
ORIGIN	Taiwan & China



M253DU



WEIGHT	242g (Al) 283g (Steel)
BODY	Plastic black
CAGE	Aluminum or Steel
SPINDLE	Boron
BEARING	Polymer bearing
SIZE	103 x 76.3 x 34.3 mm
ORIGIN	Taiwan & China



M095

WEIGHT	202g
BODY	One piece plastic black
SPINDLE	Cr-Mo
BEARING	Ball bearing
SIZE	103 x 76 x 25.5 mm
ORIGIN	Taiwan & China



M113

WEIGHT	206g
BODY	One piece plastic black
SPINDLE	Boron
BEARING	Ball bearing
SIZE	103.5 x 78 x 25.5 mm
ORIGIN	Taiwan & China

Snap in toe clip system.



**R110B**

WEIGHT	240g
BODY	Aluminum
FINISH	Barrel silver
CAGE	Aluminum
SPINDLE	Cr-Mo
BEARING	DU / Sealed
SIZE	88 x 68.6 x 29 mm
OPTION	R110 as Ball bearing version
ORIGIN	Taiwan

**R200B**

WEIGHT	242g (Al) 296g (Steel)
BODY	Aluminum
FINISH	Barrel silver
CAGE	Aluminum or Steel
SPINDLE	Cr-Mo
BEARING	DU / Sealed
SIZE	99 x 63.2 x 22 mm
OPTION	R200 as Ball bearing version R200DU as 2DU version
ORIGIN	Taiwan & China

**R251**

WEIGHT	282g
BODY	Aluminum
FINISH	ED black or painted
SPINDLE	Cr-Mo
BEARING	Polymer bearing
CLEAT	RC7A/ B/ C compatible
SIZE	87 x 89 x 32 mm
ORIGIN	Taiwan

**FEATURES:**

1. Dynamic Streamline body design.
2. Wider stepping surface offers more comfortable riding. With the stainless plate composition could prevent the body from scratch while clip in and out.
3. Stronger spring tension design makes shoes and cleats connect tighter which will improve riding efficiency.
4. Cartridge sleeve design with Wellgo New 2 DU patent system offer easy replaceable ability.

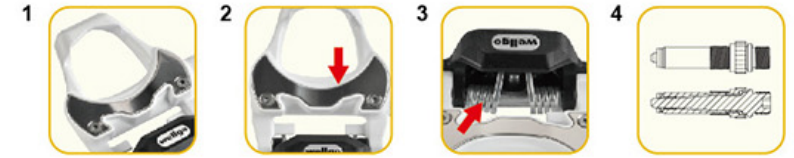
**R296RB**

WEIGHT	278g
BODY	Aluminum
FINISH	Barrel silver
CAGE	Aluminum
SPINDLE	Boron
BEARING	DU / Sealed
SIZE	109.6 x 63.4 x 24.3 mm
ORIGIN	Taiwan

**R183**

WEIGHT	272g
BODY	Aluminum
FINISH	Barrel silver or ED black
SPINDLE	Cr-Mo
BEARING	Ball bearing
SIZE	107 x 63.5 x 30 mm
OPTION	R183B as Sealed bearing version
ORIGIN	Taiwan

**R168**

WEIGHT	205g (Ti) 250g (Cr-Mo)
BODY	Engineering plastic
SPINDLE	Cr-Mo or Ti
BEARING	3 Sealed bearing
CLEAT	RC7A/ B/ C compatible
SIZE	89.8 x 81 x 32.5 mm
ORIGIN	Taiwan

**POSI-R168****WELLGO INNOVATION
Auto Reset Positioner**

By using the magnet element, the ARP helps to control the clipless step entry side as riders wish.

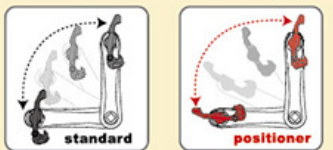

By using ARP, riders could easily clip the shoes into the pedal without looking at the pedal to reduce possible injury for missing the engagement.

R126DU

WEIGHT	274g (Al) 330g (Steel)
BODY	Aluminum
FINISH	Barrel silver
CAGE	Aluminum or Steel
SPINDLE	Boron
BEARING	Polymer bearing
SIZE	104.6 x 63 x 24 mm
OPTION	R126B as Sealed bearing version R126 as Ball bearing version
ORIGIN	Taiwan & China

**R198**

WEIGHT	304g
BODY	Plastic black
SPINDLE	Boron
BEARING	Polymer bearing
SIZE	90.9 x 96.9 x 22.5 mm
ORIGIN	Taiwan

**HR292**

WEIGHT	293g
BODY	6061 CNC Aluminum
FINISH	Anodized
SPINDLE	Cr-Mo
BEARING	3 Sealed
CLEAT	RC7A/B/C compatible
SIZE	84.5 x 90.2 x 30.2 mm
ORIGIN	Taiwan

**Cadence Pedal**

By integrating into the pedal would help eliminate attachments on the bike. It is also a tool which helps determine when is the best time to shift gears while riding to increase riding efficiency.

- 2.4g ANT+ / BLE 4.0 compatible
- 150 hrs with CR1632 button battery

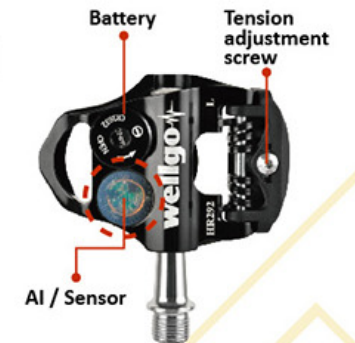

R096B

WEIGHT	242g (Ti/Mg) 292g (Cr-Mo/Mg) 326g (Cr-Mo/Al)
BODY	Aluminum / Magnesium
FINISH	ED black or painted
SPINDLE	Cr-Mo or Ti
BEARING	Needle / Sealed
CLEAT	RC7A/ B/ C compatible
SIZE	81 x 87 x 33 mm
OPTION	R096 as Ball bearing version
ORIGIN	Taiwan

**W40B**

WEIGHT	266g (Mg) 328g (Al)
BODY	Aluminum
FINISH	ED black or painted
SPINDLE	Cr-Mo
BEARING	DU / Sealed
CLEAT	RC-5 / RC-6 compatible
SIZE	85 x 92 x 33 mm
OPTION	W40 as Ball bearing version
ORIGIN	Taiwan

**R226**

WEIGHT	295g
BODY	Aluminum
FINISH	Barrel silver or painted
SPINDLE	Cr-Mo
BEARING	DU / Sealed
CLEAT	98A
SIZE	81.5 x 84.5 x 29.5 mm
ORIGIN	Taiwan

**W-44B**

WEIGHT	358g
BODY	Aluminum
FINISH	ED black or painted
SPINDLE	Cr-Mo
BEARING	DU / Sealed
CLEAT	98A
SIZE	82.8 x 76 x 46.8 mm
OPTION	W44 as Ball bearing version
ORIGIN	Taiwan

**R277**

WEIGHT	228g
BODY	6061 CNC Aluminum
FINISH	Anodized
SPINDLE	Cr-Mo
BEARING	DU / Sealed
SIZE	87 x 98.5 x 22.5 mm
ORIGIN	Taiwan

**LU-C16**

WEIGHT	230g (Ti) 280g (Cr-Mo)
BODY	6061 CNC Aluminum
FINISH	Anodized
SPINDLE	Cr-Mo or Ti
BEARING	DU / Sealed
SIZE	92.9 x 61.5 x 22 mm
ORIGIN	Taiwan

**R146**

WEIGHT	310g
BODY	Aluminum
FINISH	ED black or painted
SPINDLE	Cr-Mo
BEARING	DU / Sealed
SIZE	85 x 86 x 32 mm
ORIGIN	Taiwan

**R125**

WEIGHT	217g (Al) 272g (Steel)
BODY	Plastic black
CAGE	Aluminum or Steel
SPINDLE	Cr-Mo
BEARING	Ball bearing
SIZE	104.6 x 63.2 x 24 mm
OPTION	R125DU as 2DU version
ORIGIN	Taiwan & China

**R261DU**

WEIGHT	240g (Al) 296g (Steel)
BODY	Plastic black
CAGE	Aluminum or Steel
SPINDLE	Boron
BEARING	Polymer bearing
SIZE	104.2 x 63.2 x 23.8 mm
ORIGIN	Taiwan & China

**R199DU**

WEIGHT	215g
BODY	Plastic black
CAGE	Aluminum or Steel
SPINDLE	Boron
BEARING	Polymer bearing
SIZE	99 x 63.2 x 22 mm
OPTION	R199 as Ball bearing version
ORIGIN	Taiwan & China

**R262DU**

WEIGHT	232g (Al) 286g (Steel)
BODY	Plastic black
CAGE	Aluminum or Steel
SPINDLE	Boron
BEARING	Polymer bearing
SIZE	100.1 x 63.2 x 22 mm
ORIGIN	Taiwan & China

**R090**

WEIGHT	206g
BODY	One piece plastic black
SPINDLE	Cr-Mo
BEARING	Ball bearing
SIZE	99 x 79.8 x 24 mm
ORIGIN	Taiwan

Snap in toe clip system.



R025B

WEIGHT	238g
BODY	Aluminum
FINISH	Barrel silver
CAGE	Aluminum
SPINDLE	Cr-Mo
BEARING	DU / Sealed
SIZE	90.1 x 64.8 x 27.7 mm
OPTION	R025 as Ball bearing version
ORIGIN	Taiwan

**R104B**

WEIGHT	254g
BODY	Aluminum
FINISH	Barrel silver
CAGE	Aluminum
SPINDLE	Cr-Mo
BEARING	DU / Sealed
SIZE	104 x 65.6 x 30.8 mm
OPTION	R104 as Ball bearing version
ORIGIN	Taiwan

**MT-16**

Steel toe-clip with CP finished.
Size: M / L / XL

**MT-20**

Steel toe-clip with CP finished.
Size: M / L

**MT-21**

Steel toe-clip with CP finished.
Size: M / L

**OTHER OPTIONS**

Brown



Black

W-5

Single leather strap



White



Brown



Black

W-6

Double leather strap



White



Brown



Black

ELITE

B102B

WEIGHT	410g
BODY	Aluminum
FINISH	ED black or painted
SPINDLE	Cr-Mo
BEARING	DU / Sealed
SIZE	113.5 x 102 x 27.6 mm
OPTION	B102 as Ball bearing with mold pin
ORIGIN	Taiwan

**B230RB**

WEIGHT	445g
BODY	Aluminum with mold pin
FINISH	Barrel silver or ED black
SPINDLE	Boron
BEARING	DU / Sealed
SIZE	112.4 x 105 x 29.4 mm
ORIGIN	Taiwan & China

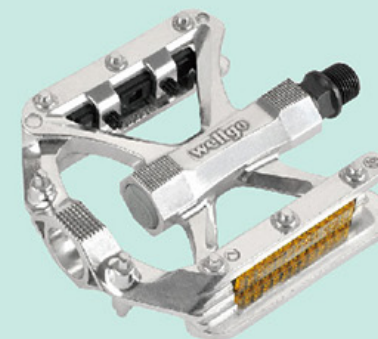

COMP

B087B

WEIGHT	374g (Mg) 450g (Al)
BODY	Aluminum / Magnesium
FINISH	ED black or Painted
SPINDLE	Cr-Mo
BEARING	DU / Sealed
SIZE	109 x 100.5 x 26 mm
OPTION	B087 as Ball bearing with mold pin B087DU as 2DU with mold pin
ORIGIN	Taiwan & China

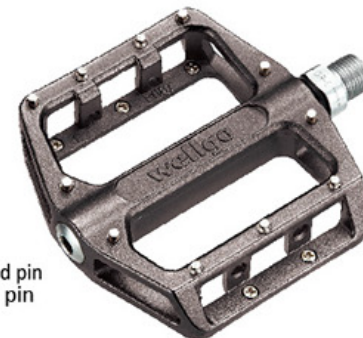
**B311**

WEIGHT	302g
BODY	Plastic black
SPINDLE	Cr-Mo
BEARING	DU / Sealed
SIZE	108 x 108 x 21 mm
ORIGIN	Taiwan



NEW

B249DU

WEIGHT	390g
BODY	Aluminum
FINISH	Barrel silver or ED black
SPINDLE	Boron
BEARING	Polymer bearing
SIZE	111.5 x 102 x 27.6 mm
ORIGIN	Taiwan & China



SELECT

B239DU

WEIGHT	276g
BODY	Plastic
SPINDLE	Boron
BEARING	Polymer bearing
SIZE	115.4 x 100 x 26 mm
OPTION	B239 as Ball bearing version
ORIGIN	Taiwan & China



NEW

B213

WEIGHT	552g
BODY	Aluminum
CAGE	Aluminum
SPINDLE	Cr-Mo
BEARING	DU / DU / Sealed
CLEAT	98A
SIZE	109.6 x 102 x 33.5 mm
ORIGIN	Taiwan



NEW

B320

WEIGHT	424g
BODY	Aluminum
FINISH	Barrel silver or ED black
CAGE	PC Translucent color
SPINDLE	Cr-Mo
BEARING	DU / Sealed
SIZE	107 x 101 x 29.8 mm
ORIGIN	Taiwan



NEW

B299DU



WEIGHT	380g
BODY	6061 CNC Aluminum
FINISH	Anodized
SPINDLE	Cr-Mo
BEARING	Polymer bearing
SIZE	109 x 105 x 23.8 mm
ORIGIN	Taiwan



NEW

B321DU



WEIGHT	378g
BODY	6061 CNC Aluminum
FINISH	Anodized
SPINDLE	Cr-Mo
BEARING	Polymer bearing
SIZE	106.1 x 105 x 22 mm
ORIGIN	Taiwan



NEW

WAM-D10

WEIGHT	516g
BODY	Magnesium
FINISH	Painted
SPINDLE	Cr-Mo
BEARING	Needle / DU / Sealed
CLEAT	98A
SIZE	109.1 x 94.7 x 33.8 mm
ORIGIN	Taiwan



B181

WEIGHT	344g
BODY	6061 Forged Aluminum
FINISH	Anodized
SPINDLE	Cr-Mo
BEARING	DU / Sealed
SIZE	115 x 102 x 10 mm
ORIGIN	Taiwan



B187

WEIGHT	306g
BODY	6061 CNC Aluminum
FINISH	Anodized
SPINDLE	Cr-Mo
BEARING	DU / Sealed
SIZE	108 x 106 x 17.8 mm
ORIGIN	Taiwan



B252

WEIGHT	300g
BODY	6061 CNC Aluminum
FINISH	Anodized
SPINDLE	Cr-Mo
BEARING	DU / Sealed
SIZE	108 x 106 x 17.5 mm
ORIGIN	Taiwan



B212

WEIGHT	372g
BODY	6061 CNC Aluminum
FINISH	Anodized
SPINDLE	Cr-Mo
BEARING	DU / Sealed
SIZE	107 x 99.6 x 28.4 mm
ORIGIN	Taiwan



B030

WEIGHT	398g
BODY	6061 CNC Aluminum
FINISH	Anodized
SPINDLE	Cr-Mo
BEARING	DU / Sealed
SIZE	109.5 x 100 x 21.9 mm
ORIGIN	Taiwan



B184

WEIGHT	356g
BODY	6061 CNC Aluminum
FINISH	Anodized
SPINDLE	Cr-Mo
BEARING	DU / Sealed
SIZE	105.5 x 100 x 27 mm
ORIGIN	Taiwan



B143



WEIGHT	384g
BODY	6061 CNC Aluminum
FINISH	Anodized
SPINDLE	Cr-Mo
BEARING	DU / Sealed
SIZE	107.3 x 100 x 26.1 mm
ORIGIN	Taiwan

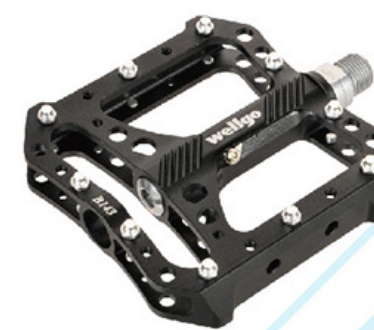

B219

WEIGHT	415g
BODY	6061 CNC Aluminum
FINISH	Anodized
SPINDLE	Cr-Mo
BEARING	DU / Sealed
SIZE	108.7 x 106.7 x 25 mm
ORIGIN	Taiwan

**MG21**

WEIGHT	298g
BODY	Magnesium
FINISH	Painted
SPINDLE	Cr-Mo
BEARING	DU / Sealed
SIZE	112 x 106 x 20.8 mm
ORIGIN	Taiwan

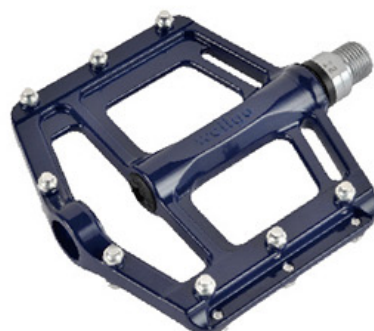
**MG2**

WEIGHT	330g
BODY	Magnesium
FINISH	Painted
SPINDLE	Cr-Mo
BEARING	DU / Sealed
SIZE	112.5 x 100 x 30.2 mm
ORIGIN	Taiwan

**B233**

WEIGHT	356g
BODY	Magnesium
FINISH	Painted
SPINDLE	Cr-Mo
BEARING	DU / Sealed
SIZE	110.5 x 100 x 26 mm
ORIGIN	Taiwan



Side View
Built in Reflector

MG-1

WEIGHT	366g
BODY	Magnesium
FINISH	Painted
SPINDLE	Cr-Mo
BEARING	DU / Sealed
SIZE	114.6 x 106.2 x 30.8 mm
ORIGIN	Taiwan

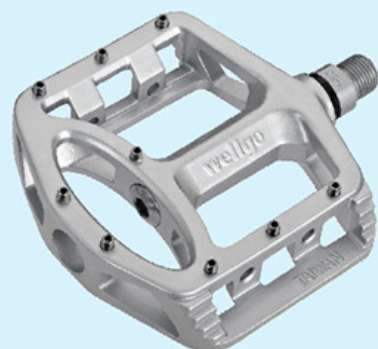
**MG32**

WEIGHT	308g
BODY	Magnesium
FINISH	Painted
SPINDLE	Boron
BEARING	Polymer bearing
SIZE	111.5 x 102 x 29.5 mm
ORIGIN	Taiwan

**MG36**

WEIGHT	320g
BODY	Magnesium
FINISH	Painted
SPINDLE	Boron
BEARING	Polymer bearing
SIZE	111.5 x 102 x 26.2 mm
ORIGIN	Taiwan

**MG3**

WEIGHT	296g
BODY	Magnesium
FINISH	Painted
SPINDLE	Boron
BEARING	Polymer bearing
SIZE	111.5 x 102 x 27.6 mm
OPTION	B249DU as Aluminum with mold pin
ORIGIN	Taiwan

**MG6-AL**

WEIGHT	362g
BODY	Aluminum
FINISH	ED black or painted
SPINDLE	Cr-Mo
BEARING	DU / Sealed
SIZE	112 x 106 x 20.8 mm
ORIGIN	Taiwan

**B155**

WEIGHT	420g
BODY	Aluminum
FINISH	ED black or Painted
SPINDLE	Cr-Mo
BEARING	Ball Bearing
SIZE	108.5 x 100 x 28 mm
OPTION	B155B as Sealed bearing version B155DU as 2DU version
ORIGIN	Taiwan

**B121**

WEIGHT	479g
BODY	Aluminum
FINISH	Barrel silver or ED black
SPINDLE	Cr-Mo
BEARING	Ball Bearing
SIZE	112 x 100 x 30.5 mm
OPTION	B121B as Sealed bearing version
ORIGIN	Taiwan

**B133**

WEIGHT	410g
BODY	Aluminum
FINISH	Barrel silver or ED black
SPINDLE	Cr-Mo
BEARING	Ball Bearing
SIZE	105.4 x 90.2 x 28 mm
OPTION	B133B as Sealed bearing version
ORIGIN	Taiwan



B223BN

WEIGHT	340g
BODY	Nylon with Fiber
SPINDLE	Cr-Mo
BEARING	DU / Sealed
SIZE	111 x 100 x 27 mm
OPTION	B223N as Ball bearing version
ORIGIN	Taiwan

**COLOR OPTION FOR PC MATERIAL****COLOR OPTION FOR NYLON MATERIAL****B107P**

WEIGHT	374g
BODY	PC Translucent color
SPINDLE	Cr-Mo
BEARING	Ball bearing
SIZE	112 x 102.4 x 28.4 mm
ORIGIN	Taiwan

**B109N**

WEIGHT	330g(PP) 370g(PC) 398g(NYLON)
BODY	Nylon with Fiber
SPINDLE	Cr-Mo
BEARING	Ball bearing
SIZE	111 x 102.5 x 30 mm
OPTION	B109P as PC Translucent color B109 as Plastic
ORIGIN	Taiwan

**B197**

WEIGHT	270g
BODY	Plastic black
SPINDLE	Cr-Mo
BEARING	Ball bearing
SIZE	106 x 90 x 31.7 mm
ORIGIN	Taiwan & China

**B123**

WEIGHT	228g
BODY	One piece plastic black
SPINDLE	Cr-Mo
BEARING	Ball bearing
SIZE	111 x 98.7 x 26.5 mm
ORIGIN	Taiwan



Quick Release Device

WELLGO QRD is available for many of our new and existing pedals in every category.

No tools are required and pedals can be removed with a flick of a finger.

The QRD design offers portability and additional security for bicycles when they are parked.

The ability to quickly remove the pedals without any tools save time when storing your bike in limited spaces (e.g. car, closet, box).

TBEA
Taiwan Bicycle
Exporters' Association

2009 TBEA Creative Bicycles, Parts
and Accessories Competition Award.



Quick Release Device



Quick Release Device



C089B

WEIGHT	232g
BODY	Aluminum
FINISH	Barrel silver
CAGE	Aluminum
SPINDLE	Cr-Mo
BEARING	DU / Sealed
SIZE	86.7 x 63.2 x 20 mm
OPTION	C089 as Ball bearing version
ORIGIN	Taiwan

**C098B**

WEIGHT	288g
BODY	Aluminum
CAGE	Plastic cage overmolded kraton
SPINDLE	Cr-Mo
BEARING	DU / Sealed
SIZE	103 x 79.5 x 24 mm
OPTION	C098 as Ball bearing version
ORIGIN	Taiwan

**C220B**

WEIGHT	362g
BODY	Aluminum with kraton top
FINISH	Barrel silver
SPINDLE	Cr-Mo
BEARING	DU / Sealed
SIZE	108 x 82 x 28 mm
OPTION	C220 as Ball bearing version C220DU as 2DU version
ORIGIN	Taiwan & China

**C322**

WEIGHT	392g
BODY	Aluminum
FINISH	Barrel silver
SPINDLE	Cr-Mo
BEARING	DU / Sealed
SIZE	105.3 x 83.5 x 24.2 mm
OPTION	C322DU as 2DU version
ORIGIN	Taiwan



NEW

C297RB

WEIGHT	282g
BODY	Aluminum
FINISH	Barrel silver
CAGE	Aluminum
SPINDLE	Boron
BEARING	DU / Sealed
SIZE	111 x 63.4 x 24.2 mm
ORIGIN	Taiwan

**C318RB**

WEIGHT	382g
BODY	Aluminum
FINISH	Barrel silver W/Sand Paper
SPINDLE	Boron
BEARING	DU / Sealed
SIZE	110 x 92 x 23.6 mm
OPTION	C318DU as 2DU version
ORIGIN	Taiwan



NEW

C235RB

WEIGHT	358g
BODY	Aluminum with kraton top
FINISH	Barrel silver
SPINDLE	Boron
BEARING	DU / Sealed
SIZE	107.8 x 81.8 x 25.8 mm
ORIGIN	Taiwan

**C169DU**

WEIGHT	366g
BODY	Aluminum with kraton top
FINISH	Barrel silver
SPINDLE	Boron
BEARING	Polymer bearing
SIZE	105 x 80 x 27 mm
OPTION	C169B as Sealed bearing version C169 as Ball bearing version
ORIGIN	Taiwan & China

**C211**

WEIGHT	326g
BODY	Plastic W/Sand Paper
SPINDLE	Boron
BEARING	Polymer bearing
SIZE	109.1 x 89.5 x 27.2 mm
ORIGIN	Taiwan

**C316DU**

WEIGHT	356g
BODY	Plastic with kraton top
SPINDLE	Boron
BEARING	Polymer bearing
SIZE	109.6 x 95.2 x 25.6 mm
OPTION	C316 as Ball bearing version
ORIGIN	Taiwan



NEW

C172DU

WEIGHT	245g
BODY	Plastic with kraton top
SPINDLE	Boron
BEARING	Polymer bearing
SIZE	106.5 x 81 x 24.8 mm
OPTION	C172 as Ball bearing version
ORIGIN	Taiwan & China



C317

WEIGHT	310g
BODY	Aluminum
FINISH	Barrel silver or painted
SPINDLE	Cr-Mo
BEARING	DU / Sealed
CLEAT	98A
SIZE	92 x 93.6 x 29.5 mm
ORIGIN	Taiwan



NEW

**FEATURES:**

1. Wider stepping surface provide more comfort while riding.
2. Stronger spring tension offers better connection between pedals and shoes which could increase the riding efficiency.
3. Tension indicator with anti-loose design prevents losing screws accidentally.

C293

WEIGHT	300g
BODY	6061 CNC Aluminum
FINISH	Anodized W/Sand Paper
SPINDLE	Cr-Mo
BEARING	DU / Sealed
SIZE	103 x 77 x 18.6 mm
ORIGIN	Taiwan

**WPD-M17C**

WEIGHT	352g
BODY	Aluminum
FINISH	Barrel silver
CAGE	Aluminum
SPINDLE	Cr-Mo
BEARING	DU / Sealed
CLEAT	98A
SIZE	100.8 x 65.2 x 27.2 mm
ORIGIN	Taiwan

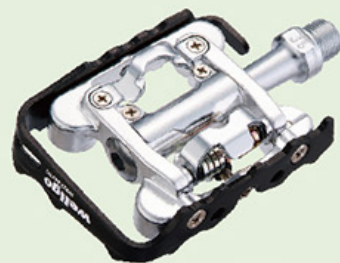
**C002B**

WEIGHT	395g
BODY	Aluminum
FINISH	Barrel silver
CAGE	Aluminum
SPINDLE	Cr-Mo
BEARING	2 Sealed
CLEAT	98A
SIZE	101.7 x 65.4 x 29.8 mm
OPTION	C002 as Ball bearing version
ORIGIN	Taiwan

**C176B**

WEIGHT	344g
BODY	Aluminum
FINISH	ED black
CAGE	Aluminum
SPINDLE	Cr-Mo
BEARING	DU / Sealed
CLEAT	98A
SIZE	104 x 63.2 x 28 mm
OPTION	C176 as Ball bearing version
ORIGIN	Taiwan

**WPD-95B**

WEIGHT	446g
BODY	Aluminum
FINISH	Barrel silver
CAGE	Aluminum
SPINDLE	Cr-Mo
BEARING	DU / Sealed
CLEAT	98A
SIZE	101.7 x 65.4 x 29.8 mm
ORIGIN	Taiwan

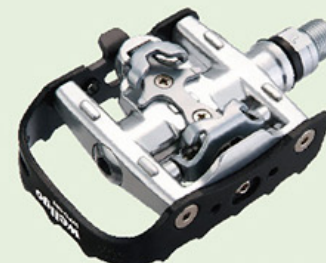
**C006**

WEIGHT	214g
BODY	6061 CNC Aluminum
FINISH	Anodized
SPINDLE	Cr-Mo
BEARING	DU / Sealed
SIZE	95 x 61.5 x 22.9 mm
ORIGIN	Taiwan

**C266**

WEIGHT	230g
BODY	6061 CNC Aluminum
FINISH	Anodized
SPINDLE	Cr-Mo
BEARING	DU / Sealed
SIZE	90 x 78 x 25 mm
ORIGIN	Taiwan

**C271**

WEIGHT	220g
BODY	6061 CNC Aluminum
FINISH	Anodized
SPINDLE	Cr-Mo
BEARING	DU / Sealed
SIZE	95.5 x 78 x 24.5 mm
ORIGIN	Taiwan

**C260**

WEIGHT	188g (Ti) 230g (Cr-Mo)
BODY	6061 CNC Aluminum
FINISH	Anodized
SPINDLE	Ti or Cr-Mo
BEARING	DU / Sealed
SIZE	82 x 100 x 24 mm
ORIGIN	Taiwan



QRDII-C231B 

WEIGHT	300g (Mg) 379g (Al)
BODY	Aluminum
FINISH	ED black or painted
SPINDLE	Cr-Mo
BEARING	DU / Sealed
SIZE	102 x 100 x 26 mm
ORIGIN	Taiwan

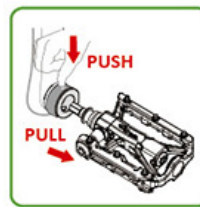

The pedal could be locking at front or rear spoke as a locker

FEATURES:

To solve the noising sound while riding on bumpy road and the inconvenience for carry locks outdoor, wellgo locking pedal has been connected the pedal and the lock. It offers the rider to easily remove the pedal and put it onto the spoke as a lock. Locking pedal design is compatible to all bikes.

C237 

WEIGHT	236g
BODY	6061 Forged Aluminum
FINISH	Anodized
SPINDLE	Cr-Mo
BEARING	DU / Sealed
SIZE	102 x 74 x 20.8 mm
ORIGIN	Taiwan

**C280DU** 

WEIGHT	327g
BODY	Aluminum
FINISH	Barrel silver
SPINDLE	Boron
BEARING	Polymer bearing
SIZE	104.9 x 77.6 x 24 mm
ORIGIN	Taiwan & China

**C238** 

WEIGHT	280g
BODY	6061 CNC Aluminum
FINISH	Anodized
CAGE	Aluminum
SPINDLE	Cr-Mo
BEARING	DU / Sealed
SIZE	110 x 67.2 x 23 mm
ORIGIN	Taiwan



OPEN AS THE STAND

C210 

WEIGHT	359g
BODY	Aluminum
FINISH	Barrel silver
SPINDLE	Cr-Mo
BEARING	Ball bearing
SIZE	102 x 75 x 25 mm
OPTION	C210B as Sealed bearing version
ORIGIN	Taiwan & China

**C227DU** 

WEIGHT	326g
BODY	Aluminum
FINISH	ED black or painted
SPINDLE	Boron
BEARING	Polymer bearing
SIZE	99 x 84 x 26.5 mm
OPTION	C227B as Sealed bearing version
ORIGIN	Taiwan

**C276**

WEIGHT	378g
BODY	Aluminum
FINISH	Barrel silver
CAGE	Aluminum
SPINDLE	Boron
BEARING	Ball bearing
SIZE	102.5 x 70.5 x 28 mm
ORIGIN	Taiwan

**C128** 

WEIGHT	250g (Al) 309g (Steel)
BODY	Aluminum
FINISH	Barrel silver
CAGE	Aluminum or Steel
SPINDLE	Cr-Mo
BEARING	Ball bearing
SIZE	106.3 x 63 x 24 mm
OPTION	C128B as Sealed bearing version C128DU as 2DU version
ORIGIN	Taiwan & China

**C127** 

WEIGHT	226g (Al) 295g (Steel)
BODY	Plastic black
CAGE	Aluminum or steel
SPINDLE	Cr-Mo
BEARING	Ball bearing
SIZE	106.3 x 63 x 24 mm
OPTION	C127DU as 2DU version
ORIGIN	Taiwan & China



C32B

WEIGHT	324g
BODY	Aluminum with kraton top
FINISH	Barrel silver
SPINDLE	Cr-Mo
BEARING	DU / Sealed
SIZE	102.9 x 69.6 x 24.2 mm
OPTION	C32 as Ball bearing version
ORIGIN	Taiwan

**C016**

WEIGHT	460g
BODY	Aluminum with kraton top
FINISH	Barrel silver
SPINDLE	Cr-Mo
BEARING	Ball bearing
SIZE	106 x 91 x 30 mm
OPTION	C016B as Sealed bearing version
ORIGIN	Taiwan

**F265**

WEIGHT	436g
BODY	Aluminum
FINISH	Barrel silver or ED black
CAGE	Aluminum
SPINDLE	Boron
BEARING	Polymer bearing
SIZE	105 x 89.3 x 24.2 mm
ORIGIN	Taiwan & China

**F268**

WEIGHT	370g
BODY	Aluminum
FINISH	Barrel silver or ED black
CAGE	PC black
SPINDLE	Boron
BEARING	Polymer bearing
SIZE	104.7 x 84 x 28.2 mm
ORIGIN	Taiwan & China

**C097**

WEIGHT	244g
BODY	Plastic with kraton top
SPINDLE	Cr-Mo
BEARING	Ball bearing
SIZE	103 x 79.5 x 24 mm
ORIGIN	Taiwan

**C157**

WEIGHT	270g
BODY	Plastic with kraton top
SPINDLE	Boron
BEARING	Ball bearing
SIZE	99 x 63.3 x 24.5 mm
ORIGIN	Taiwan & China

**F278**

WEIGHT	396g
BODY	PC black
CAGE	Aluminum
SPINDLE	Boron
BEARING	Polymer bearing
SIZE	104.7 x 84 x 28.2 mm
ORIGIN	Taiwan & China

**F284**

WEIGHT	328g
BODY	PC black
CAGE	PC black
SPINDLE	Boron
BEARING	Polymer bearing
SIZE	104.7 x 84 x 28.2 mm
ORIGIN	Taiwan & China

**C246DU**

WEIGHT	246g
BODY	One piece plastic black
SPINDLE	Boron
BEARING	Polymer bearing
SIZE	106.3 x 80.9 x 23.8 mm
ORIGIN	Taiwan & China

**F178DU**

WEIGHT	328g
BODY	PC black
CAGE	PC black
SPINDLE	Boron
BEARING	Polymer bearing
SIZE	98 x 72.2 x 26 mm
ORIGIN	Taiwan & China

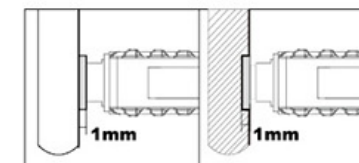

The washer could offer better contact while install the pedal into crank arm.

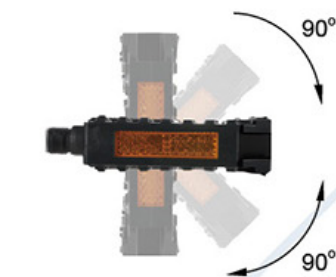

FOLDING PEDAL

F315

WEIGHT	296g
BODY	Nylon with Fiber
CAGE	Nylon with Fiber
SPINDLE	Cr-Mo
BEARING	Bushing bearing
SIZE	100.2 x 65.7 x 27.2 mm
ORIGIN	Taiwan & China



1. Pull up the locker.



2. Open the cage.



3. Till it is completed opened.

NEW

LIGHTER AND MORE SPACE SAVING

Wing style folded concept, only 4 cm out from the crank. The folding construction is vertical direction from the pedal loading position. This mechanism is even more security for usage. It could also improve the conventional issue for play and abnormal sound.

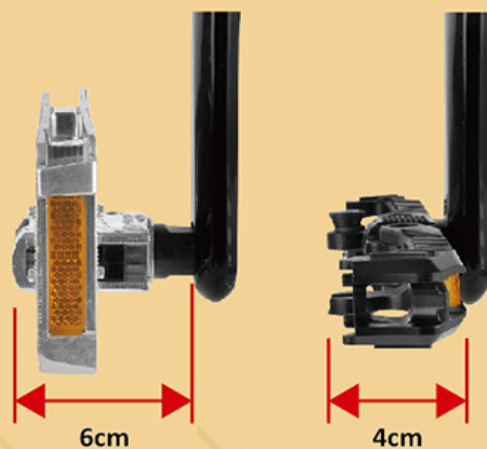

YOUTH PEDAL

J314

WEIGHT	218g
BODY	One piece plastic black
SPINDLE	Boron
BEARING	Ball-less
SIZE	93.2 x 80 x 30 mm
ORIGIN	Taiwan



Built in Reflector

NEW



To make everyone's life easier, Wellgo developed the new Snap on spindle system for the youth pedal. Now the spindle can be directly assembled onto the bike before shipment. Once the bike hits the store, users can simply take the body out and snap it on to the spindle. This would help prevent identifying the threads and minimize the trouble of assembling pedals.

LU-P21

WEIGHT	288g
BODY	One piece plastic black
SPINDLE	Boron
BEARING	Ball bearing
SIZE	90 x 65 x 31 mm
ORIGIN	Taiwan & China

**LU-P17**

WEIGHT	298g
BODY	One piece plastic black
SPINDLE	Boron
BEARING	Ball bearing
SIZE	92 x 85.5 x 29.5 mm
ORIGIN	Taiwan & China

**C283**

WEIGHT	208g
BODY	Plastic black
SPINDLE	Boron
BEARING	Ball-less
SIZE	88.5 x 67.7 x 24.8 mm
ORIGIN	Taiwan & China

**LU-873**

WEIGHT	252g
BODY	One piece plastic black
FINISH	Boron
SPINDLE	Ball bearing
BEARING	90 x 65 x 29 mm
SIZE	LU-873NB as Ball-less version
ORIGIN	Taiwan & China

**LU-937NB**

WEIGHT	228g
BODY	One piece plastic black
SPINDLE	Steel
BEARING	Ball-less
SIZE	95 x 64 x 27 mm
ORIGIN	Taiwan & China

**LU-892DU**

WEIGHT	290g
BODY	One piece plastic black
SPINDLE	Boron
BEARING	Polymer bearing
SIZE	99 x 75 x 31 mm
OPTION	LU-892 as Ball bearing version
ORIGIN	Taiwan & China

**LU-968**

WEIGHT	282g
BODY	One piece plastic black
SPINDLE	Boron
BEARING	Ball bearing
SIZE	95.5 x 81.5 x 29.5 mm
ORIGIN	Taiwan & China

**B267**

WEIGHT	288g(PP) 336g(NYLON)
BODY	Plastic black
SPINDLE	Cr-Mo
BEARING	Ball bearing
CAGE	106.3 x 93.9 x 27.6 mm
SIZE	B267N as Nylon with fiber
ORIGIN	Taiwan

**LU-204**

WEIGHT	416g
BODY	Aluminum
FINISH	Barrel silver or ED black
SPINDLE	Boron
BEARING	Ball bearing
SIZE	94.2 x 84.2 x 29.8 mm
ORIGIN	Taiwan & China

**LU-964**

WEIGHT	344g (Al) 425g (Steel)
BODY	Aluminum
FINISH	Barrel silver
CAGE	Aluminum or Steel
SPINDLE	Boron
BEARING	Ball bearing
SIZE	102 x 70 x 32 mm
ORIGIN	Taiwan & China

**LU-C3**

WEIGHT	296g(Al) 386g(Steel)
BODY	Plastic black
CAGE	Aluminum or Steel
SPINDLE	Boron
BEARING	Ball bearing
SIZE	103 x 63 x 28 mm
ORIGIN	Taiwan & China

**LU-207**

WEIGHT	326g
BODY	One piece plastic black
SPINDLE	Boron
BEARING	Ball bearing
SIZE	105.9 x 80.8 x 29.5 mm
ORIGIN	Taiwan & China



E229B

WEIGHT	776g
BODY	Aluminum
FINISH	ED black
SPINDLE	Cr-Mo
BEARING	3 Sealed
CLEAT	98A
SIZE	100.5 x 79 x 34 mm
ORIGIN	Taiwan

**WPD-E14B**

WEIGHT	832g
BODY	Aluminum with kraton top
FINISH	Barrel silver
SPINDLE	Cr-Mo
BEARING	DU / Needle / Sealed
CLEAT	98A
SIZE	109 x 80.2 x 34.8 mm
OPTION	E14B as W/O QBS WPD-E14 as Ball bearing version
ORIGIN	Taiwan

**WPD-E003B**

WEIGHT	774g
BODY	Aluminum
FINISH	ED black
SPINDLE	Cr-Mo
BEARING	3 Sealed
CLEAT	98A
SIZE	102.4 x 72.4 x 34.9 mm
OPTION	E003B as W/O QBS WPD-E003 as Ball bearing version
ORIGIN	Taiwan

**E003B**

WEIGHT	672g
BODY	Aluminum
FINISH	ED black
SPINDLE	Cr-Mo
BEARING	3 Sealed
CLEAT	98A
SIZE	102.4 x 72.4 x 34.9 mm
OPTION	WPD-E003B as W/QBS E003 as Ball bearing version
ORIGIN	Taiwan

**E14B**

WEIGHT	728g
BODY	Aluminum
FINISH	Barrel silver with kraton top
SPINDLE	Cr-Mo
BEARING	DU / Needle / Sealed
CLEAT	98A
SIZE	109 x 80.2 x 34.8 mm
OPTION	WPD-E14B as W/QBS E14 as Ball version
ORIGIN	Taiwan

**EX-13**

WEIGHT	1012g
BODY	Plastic black with Pu Strap
SPINDLE	Boron
BEARING	Ball bearing
SIZE	115.2 x 130.9 x 51 mm
ORIGIN	Taiwan

**E179**

WEIGHT	578g
BODY	Aluminum
FINISH	Barrel silver
SPINDLE	Cr-Mo
BEARING	Ball bearing
CAGE	Steel / ED black
SIZE	113 x 62.6 x 30 mm
OPTION	Toe clip & strap mountable
ORIGIN	Taiwan



1 Push down the buckle

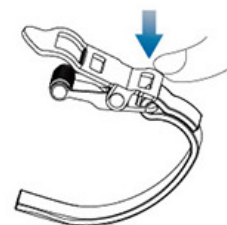

2 Have the strap through the buckle



3 Release the buckle

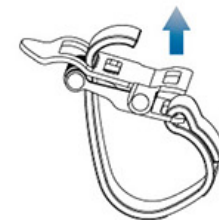

4 Have the strap go through the upper hole of the buckle to hold the strap

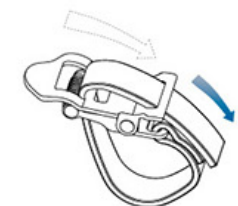

LU-948

WEIGHT	304g (Al) 388g (Steel)
BODY	Plastic black
CAGE	Aluminum or Steel
SPINDLE	Boron
BEARING	Ball bearing
SIZE	98 x 74 x 30 mm
ORIGIN	Taiwan & China

**LU-209**

WEIGHT	436g
BODY	Aluminum
FINISH	Barrel silver
SPINDLE	Boron
BEARING	Ball bearing
SIZE	87.2 x 86.4 x 29.8 mm
ORIGIN	Taiwan & China

**R-11**

WEIGHT	362g
BODY	Plastic black
CAGE	Aluminum
SPINDLE	Boron
BEARING	Ball bearing
SIZE	99 x 63 x 29 mm
ORIGIN	Taiwan & China

**LU-984**

WEIGHT	316g
BODY	One piece plastic black
SPINDLE	Boron
BEARING	Ball bearing
SIZE	107 X 95.5 X 28 mm
OPTION	LU-984DU as 2DU version
ORIGIN	Taiwan & China

**LU-313**

WEIGHT	480g
BODY	Aluminum
FINISH	ED black or painted
SPINDLE	Boron
BEARING	Ball bearing
SIZE	109.5 x 105 x 30 mm
ORIGIN	Taiwan & China

**LU-P9**

WEIGHT	344g
BODY	One piece plastic black
SPINDLE	Boron
BEARING	Ball bearing
SIZE	108 x 105 x 32.5 mm
ORIGIN	Taiwan & China

**LU-205**

WEIGHT	336g
BODY	One piece plastic black
SPINDLE	Boron
BEARING	Ball bearing
SIZE	111.5 x 99 x 31.5 mm
ORIGIN	Taiwan & China

**LU-B78**

WEIGHT	350g
BODY	One piece plastic black
SPINDLE	Boron
BEARING	Ball bearing
SIZE	100.5 X 95.5 X 32 mm
ORIGIN	Taiwan & China

**LU-975**

WEIGHT	464g
BODY	Aluminum with kraton top
FINISH	Barrel silver
SPINDLE	Boron
BEARING	Ball bearing
SIZE	103 x 71.5 x 31 mm
ORIGIN	Taiwan & China

**LU-884**

WEIGHT	392g
BODY	Plastic with kraton top
SPINDLE	Boron
BEARING	Ball bearing
SIZE	105 x 72 x 32 mm
ORIGIN	Taiwan & China

**LU-990**

WEIGHT	406g
BODY	Plastic with kraton top
SPINDLE	Boron
BEARING	Ball bearing
SIZE	106.5 x 94 x 33.2 mm
ORIGIN	Taiwan & China



TOE CLIP

MT-3

Double supportive design with instep guard. MT-3 size L, MT-4 size S, MT-5 size M.



MT-6

Large supportive design with instep guard.



MT-7

Mini toe-clip
Size: 82.7 x 53.8mm



RP-1

Classic road racing toe-clip
Size: M / L



MT-10

Strapless toe-clip for technical or casual riding.



MT-11

Large supportive design with instep guard and built-in reflector. MT-11 size L, MT-12 size M.



MT-14

Double supportive design with built-in reflector. MT-13 size M, MT-14 size L.



MT-19

Size: S / M / L / XL



NYLON TOE-STRAP

W-4

Nylon toe-strap with heavy-duty buckle.



Black

W-2



Black

STRAP

W8



Black



SPINDLE

K001

Axle replacement kit.

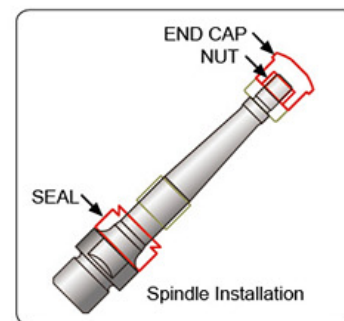

K004

Bearing replacement kit.

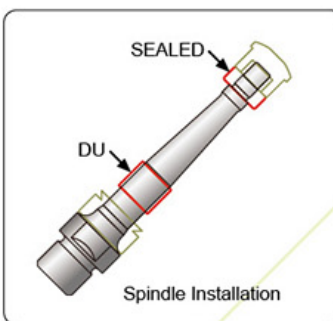

PIN OPTIONS

Color:



D1-Pin
28-7 8mm



A-Pin
28-B19 8mm
28-B7 6mm



U-Pin
28-11 11mm
28-12 12mm



D2-Pin
28-2 8mm



C-Pin
33-C9 9mm



V-Pin
33-V9 9.5mm



R-Pin
33-R9 9.5mm

REFLECTOR

RR1-5



BOLT TYPE

Bolt-on reflector set for standard MTB pedals. 25 g/pr

SNAP ON

Snap-on reflector set.

LONG SNAP ON

Extra-long snap-on reflector set.

WRENCH



98A-2 (60 g/pr)

Reflector for pedal
715 · 801 · 823 · M19 · M717 · M919 · MG8

98A-3 (60 g/pr)

Reflector for pedal
M094 · M18 · W01 · XMF3

How to use 98A Reflector platform

1

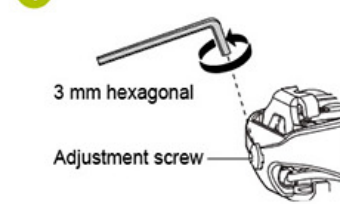

Use a 3mm hexagonal wrench to adjust the spring tension to the lowest tension.

2

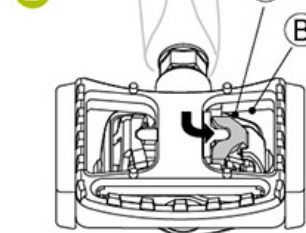

First, insert (A) point of the reflector platform into the front side of the pedal claw.

3

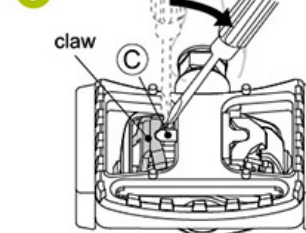

Use a straight (flat) screwdriver to push the back claw backwards for easier access to the reflector platform.

4

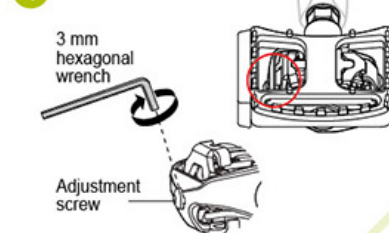

Once the reflector platforms are installed to the pedal, please adjust the spring tension to fit your need.

CLEAT



98R (77 g/pr)
Cleat kit. 4 degree float



98A (52 g/pr)
Cleat kit with improved mud clearance features. 4 degree float



99A (49 g/pr)
Cleat kit. 4 degree float

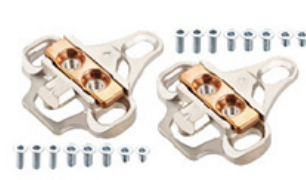

RC8 (126 g/pr)
New cleat design for mountain clipless pedal to be assembled on LOOK style shoes.
MATERIAL : Cr-Mo



RC-3 (105 g/pr)
Cleat kit for WAM-R2 and R4. 4 degree float



RC-7A (82 g/pr)
Cleat kit for R096, R168 & E148 9 degree lateral float



RC-7B (82 g/pr)
Cleat kit for R096, R168 & E148 6 degree lateral float



RC-7C (82 g/pr)
Cleat kit for R096, R168 & E148 0 degree lateral float



RC-5 (90 g/pr)
Cleat kit for WAM-R1, R3 and MG-9, W40, CR-1. 9 degree lateral float



RC-6 (90 g/pr)
Cleat kit for WAM-R1, R3 and MG-9, W40, CR-1. 0 degree lateral float

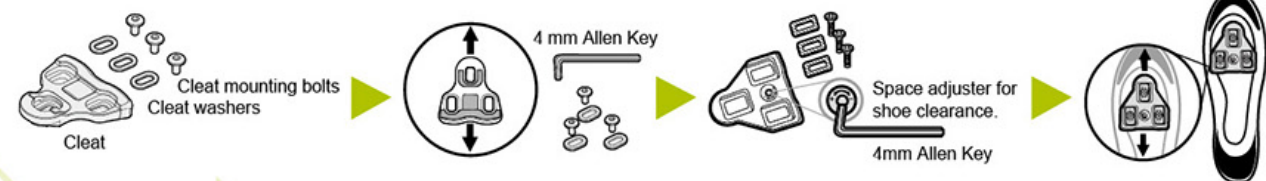

CLEAT PACKAGE

CLEAT APPLICATION TABLE



	WPD 823DU	M279	M250	M177B	W-01	WAM M19	M094B	WAM M919	R251	R168	HR292	R096B	W40B	R226	W-44	B213	WAM D10	C317	WPD M17C	C002B	C176B	WPD 95B	E229B	WPD E003	WPD E14	
98A	4°	4°	4°	4°	4°	4°	4°	4°						4°	4°	4°	4°	4°	4°	4°	4°	4°	4°	4°	4°	4°
RC8	4°	4°	4°	4°	4°	4°	4°	4°						4°	4°	4°	4°	4°	4°	4°	4°	4°	4°	4°	4°	4°
98R															4°											
RC5													9°													
RC6														0°												
RC7A									9°	9°	9°	9°														
RC7B									6°	6°	6°	6°														
RC7C									0°	0°	0°	0°														



wellgo

WELLGO PEDAL'S CORP.

No.3, Gong 7th Road, Youth Ind.Park, Dajia Dist., Taichung City 437, Taiwan
TEL: 886-4-26816991-5 [HTTP: //www.wellgopedal.com](http://www.wellgopedal.com)
FAX: 886-4-2681-6988, 2681-6998 E-MAIL: wd@wellgopedal.com

SHANGHAI FACTORY

No.103, Yuehd-Ho South Road Economic & Technical
Development Zone, Kunshan, Jiangsu, China
TEL: 86-512-57701991-4 [HTTP: //www.wellgopedal.cn](http://www.wellgopedal.cn)
FAX: 86-512-57701995 E-MAIL: wellgo@wellgopedal.cn